

Final 14 October 2019

Tamanna

An Aptitude Test for Senior School Students

TEST BOOKLET

Anjum Sibia

Prabhat K. Mishra
Sushmita Chakraborty
Sunita Devi

Shraddha Dhiwal
Ruchi Shukla
Jyoti Gupta

Tamanna: An Aptitude Test - LA

Instructions

Find the space for LA-01 in your Answer Sheet. Answer all questions as directed.

This test consists of three parts - Part I, II and III.

PART I

Part I has 10 items (Questions 1-10). First look at the word in capital letters. There are four options - A, B, C and D. Find the word which means the same as the word in capitals from the given options.

An example is given below:

Example X

MEMORABLE: A. Unforgettable B. Interesting C. Attractive D. Eventful

In the above example, note that MEMORABLE and UNFORGETTABLE mean the same thing.

Therefore option "A" is the correct answer. Mark the answer in the given answer sheet by darkening the circle as shown below:

Correct way of marking the answer ⇒ ● (B) (C) (D)

Practice Item

AMAZING: A. Dutiful B. Wonderful C. Joyful D. Beautiful

You are to mark the correct answer of the practice item in the answer sheet.

Answer: B

PART II

Part II has 10 items (Questions 11-20). Each item has a series of words. Out of the four options- A, B, C and D, find the word that has been spelt correctly.

An example is given below:

Example Y

A. Goverment B. Government C. Gorment D. Govenmant

Out of the four options given, the word 'Government' (option 'B') has been spelt correctly. In this example, the right answer is option "B".

Practice Item

A. Precotion B. Pricaution C. Precausion D. Precaution

You are to mark the correct answer of the practice item in the answer sheet.

Answer: D

PART III

Part III has 10 items (Questions 21-30). Read the proverb / idiom given in bold letters. Then, choose the correct/or nearest meaning of the proverb/idiom from the given options - A, B, C and D.

Example Z

Cry over spilt milk.

- A. Getting out of difficulty.
- B. Holding hatred against someone.
- C. Complaining about a loss from the past.
- D. Anticipating about the future and crying.

Since ‘**Cry over spilt milk**’ means about the same as **complaining about a loss from the past**.

In this example, the right answer is “C”.

Practice Item

The grass is always greener on the other side.

- A. People are looking at the other side.
- B. People want green grass.
- C. People always want what they don’t have.
- D. People think that grass grows better on other side.

You are to mark the correct answer of the practice item in the answer sheet.

Answer: C

You will have **10 minutes** for this test-Part I, II and III. Work as quickly as possible.

DO NOT MARK ANYTHING ON THIS BOOKLET.

PART I

1. **REMEDY:** A. Treatment B. Rejection C. Prevention D. Protection
2. **STAMINA:** A. Warmth B. Depth C. Strength D. Boldness
3. **CAUTIOUS:** A. Helpful B. Kind C. Diligent D. Careful
4. **CLUMSY:** A. Awkward B. Different C. Varied D. Arrogant
5. **ANCESTOR:** A. Grandfather B. Forefather C. Elderly D. Antique
6. **FATAL:** A. Dangerous B. Simple C. Severe D. Deadly
7. **PERSUADE:** A. Discuss B. Convince C. Debate D. Converse
8. **PROSPERITY:** A. Wealth B. Health C. Wisdom D. Comfort
9. **CONTAMINATE:** A. Combine B. Erode C. Suspend D. Pollute
10. **ACCOUNTABLE:** A. Dependable B. Answerable C. Sincere D. Dutiful

PART II

11. A. Illeterate B. Illiterate C. Iliterate D. Illitrate
12. A. Procede B. Procede C. Procead D. Proceed
13. A. Sanitasion B. Sanitation C. Sanitetion D. Sanetation
14. A. Skillful B. Skillfull C. Skiilful D. Skilfull
15. A. Occasin B. Ocassin C. Occasion D. Ocassion
16. A. Argument B. Arguement C. Arguemint D. Arguiment
17. A. Existance B. Existense C. Existanse D. Existence
18. A. Transsnision B. Transmisson C. Transmission D. Transmision
19. A. Privilege B. Privlege C. Privelege D. Previlge
20. A. Vaccination B. Vaccination C. Vaxination D. Vaccenation

Go on to the next page

PART III

21. **Kill two birds with one stone.**
- A. To achieve two different things with a single action.
 - B. To trap two birds with one stone.
 - C. To throw the stone onto others.
 - D. To have two opportunities.
22. **Burn the midnight oil.**
- A. Work late into the night.
 - B. Would never like to do something.
 - C. Work hard to achieve targets.
 - D. Finish two different things on time.
23. **Beat around the bush.**
- A. To hide from someone.
 - B. To try and remain distant.
 - C. To avoid making an eye contact.
 - D. To avoid speaking on the main topic of discussion.
24. **Hit the nail on the head.**
- A. To make something new.
 - B. To do carpenters work.
 - C. To do exactly the right thing.
 - D. To announce one's fixed views.
25. **To keep one's temper.**
- A. To stop talking.
 - B. To hold one's anger.
 - C. To be aloof.
 - D. To become angry.
26. **Not a spark of decency.**
- A. A person who has no rights.
 - B. A person who has no duties.
 - C. A person who has no manners.
 - D. A person who has no energy.

27. **Don't judge a book by its cover.**
- A. Don't judge something by its colour.
 - B. Don't judge a book by its price.
 - C. Don't judge something by its appearance.
 - D. Don't judge something from outside.
28. **Add insult to injury.**
- A. To worsen a negative situation.
 - B. To insult a physically injured person.
 - C. To laugh at someone.
 - D. To taunt someone.
29. **Honesty is the best policy.**
- A. It is better to lie than to say truth.
 - B. Honesty is equivalent to truth.
 - C. Honesty is equal to making a policy.
 - D. It is better to tell the truth than lie.
30. **Make hay while the sun shines.**
- A. Take advantage of yourself.
 - B. Take advantage of the opportunity.
 - C. Take advantage of the sun.
 - D. Take advantage of the hay.

DO NOT START THE NEXT TEST UNTIL YOU ARE TOLD TO DO SO.

Tamanna: An Aptitude Test - AR

Instructions

Find the space for **AR-02** in your Answer Sheet. Answer all questions as directed.

In this test, there are 30 questions. You will see rows of designs or figures like those given below in the example.

Each row consists of four figures called Problem Figures followed by Answer Figures which have four options- A, B, C and D. The Problem Figures follow a certain sequence. You need to find out which one of the Answer Figures would be the next in the sequence of Problem Figures.

Look at the following example:

Example X

Problem Figures

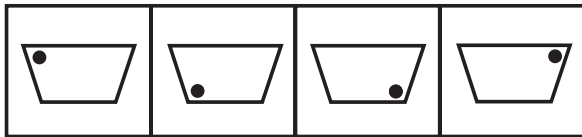

Answer Figures

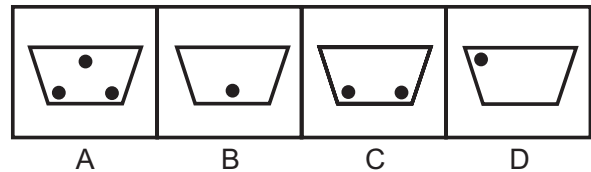

In the above example, note that each of the four problem figures has a shape with a dot. As you can see the dot in the problem figures moves anti-clockwise (↻). So, the correct option in the answer figure would be the one in which the dot shows the next anti-clockwise position.

In this example, right answer is "D", therefore, darken the circle of option D in the answer sheet as shown below:

Correct way of marking the answer → A B C D

Practice Item:

Problem Figures

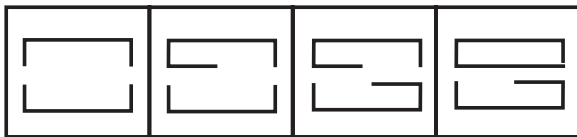

Answer Figures

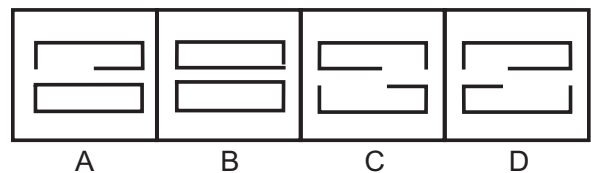

You are to mark the correct answer of the practice item in the answer sheet.

Answer: B

You will have **10 minutes** for this test. Work as quickly as possible.

DO NOT MARK ANYTHING ON THIS BOOKLET.

Problem Figures

Answer Figures

1.

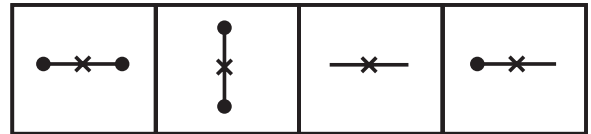
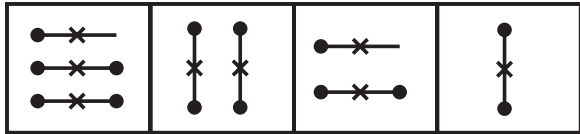

A

B

C

D

2.

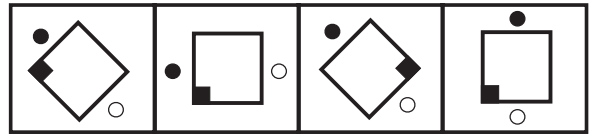
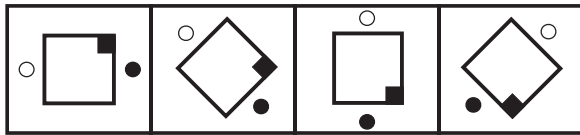

A

B

C

D

3.

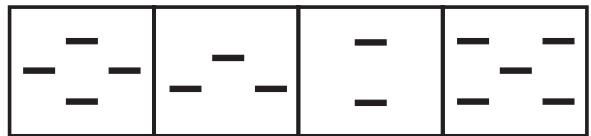
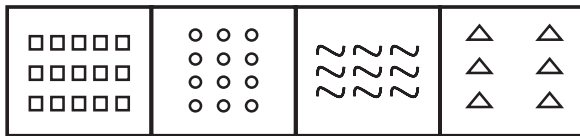

A

B

C

D

4.

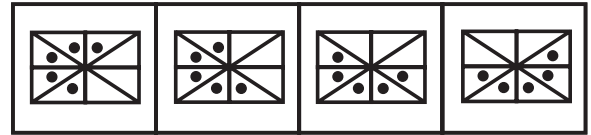
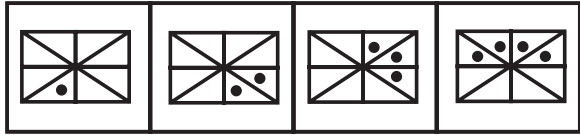

A

B

C

D

5.

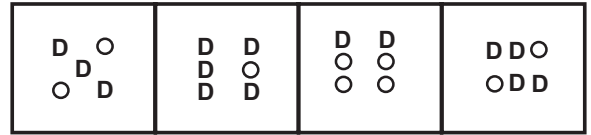
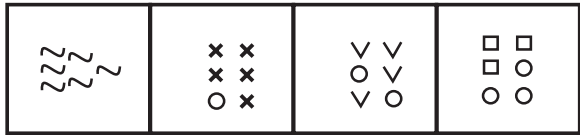

A

B

C

D

6.

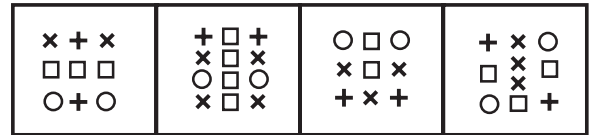
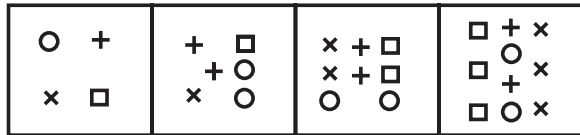

A

B

C

D

7.

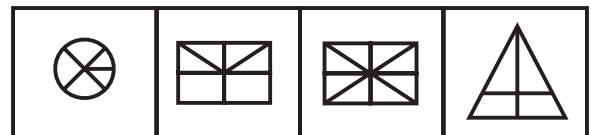

A

B

C

D

Problem Figures

Answer Figures

8.

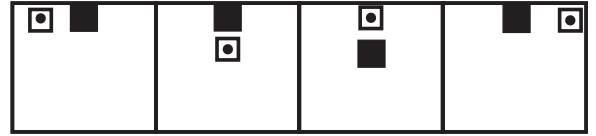
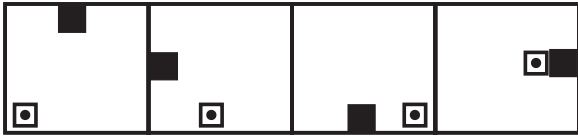

A

B

C

D

9.

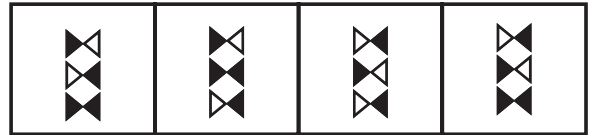
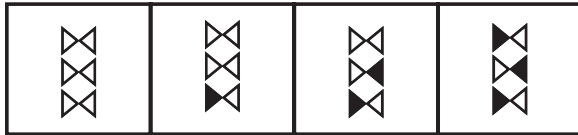

A

B

C

D

10.

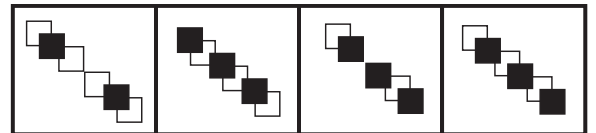
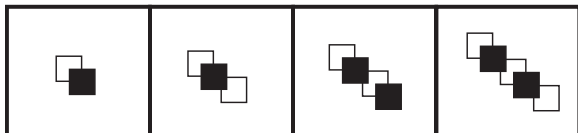

A

B

C

D

11.

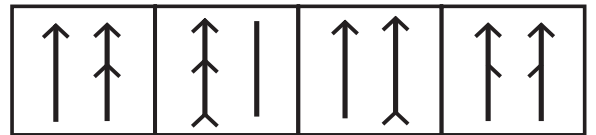
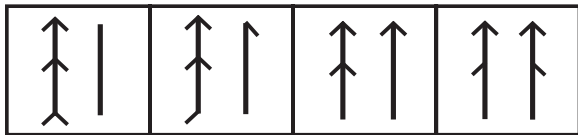

A

B

C

D

12.

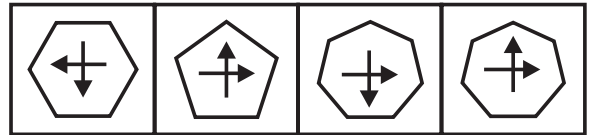
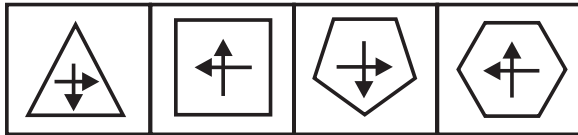

A

B

C

D

13.

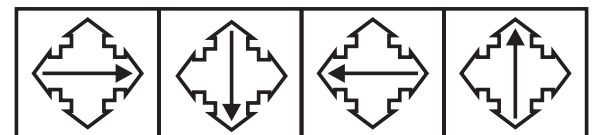
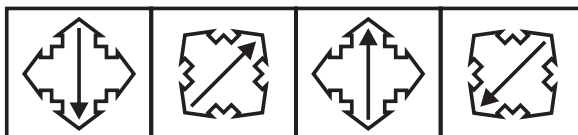

A

B

C

D

14.

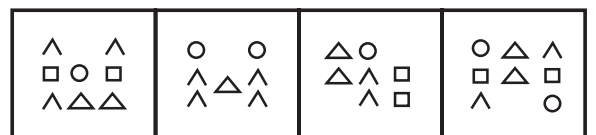
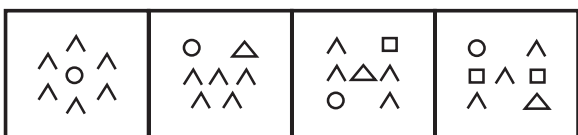

A

B

C

D

Problem Figures

Answer Figures

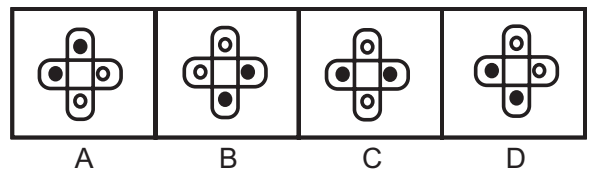
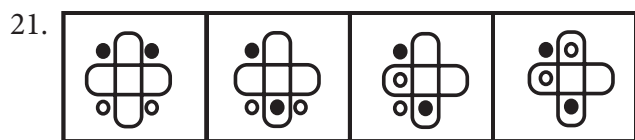
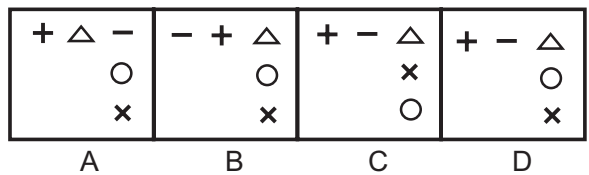
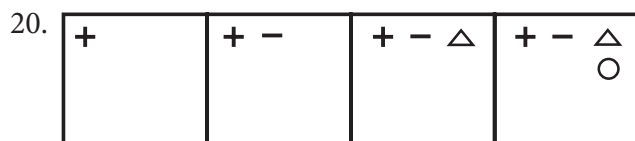
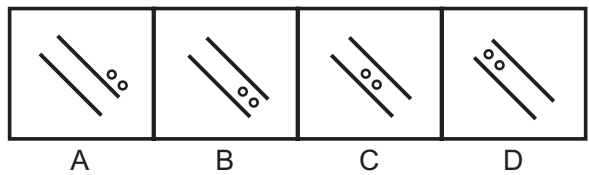
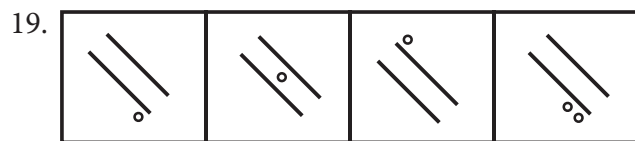
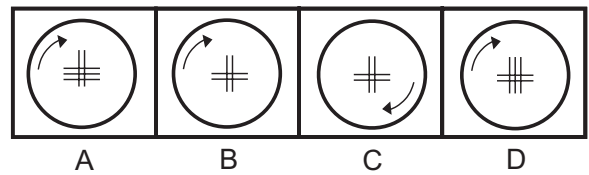
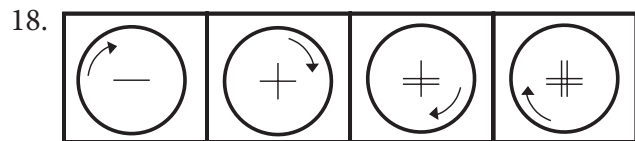
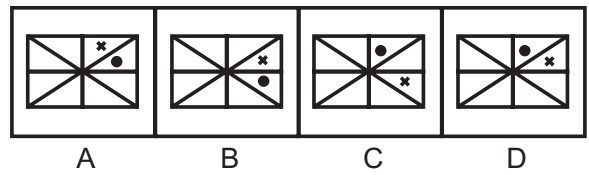
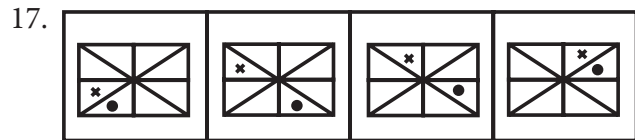
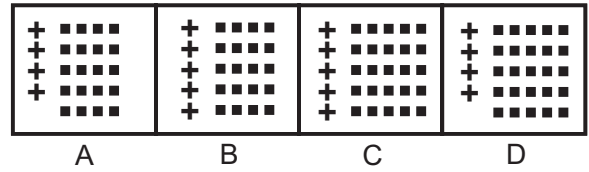
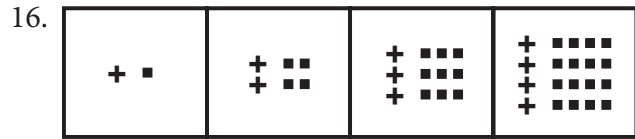
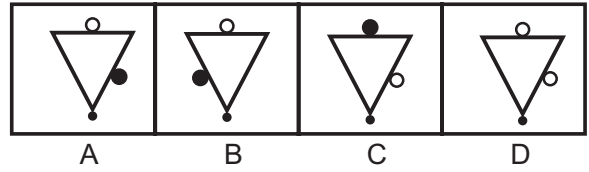
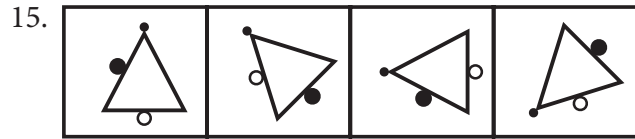

Problem Figures

Answer Figures

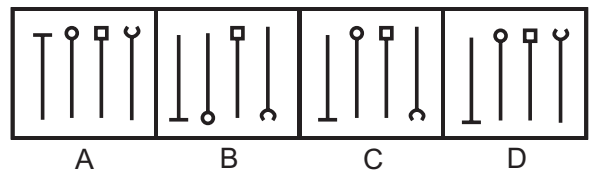
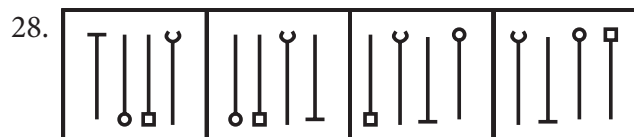
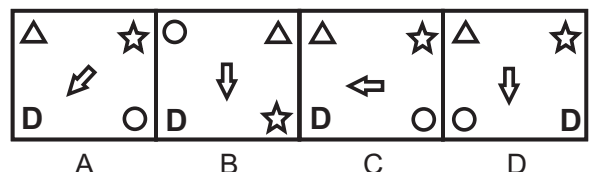
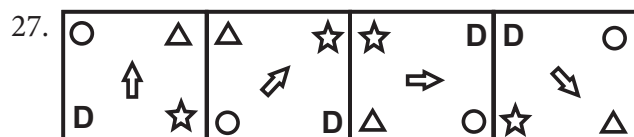
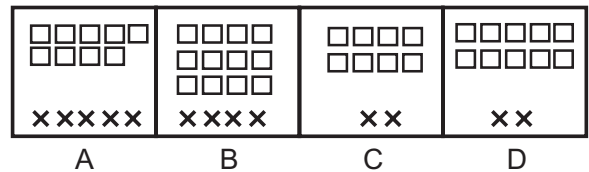
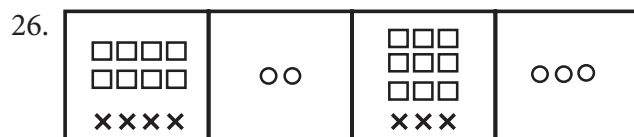
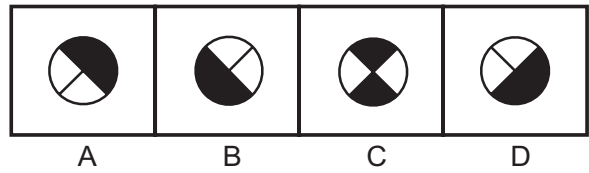
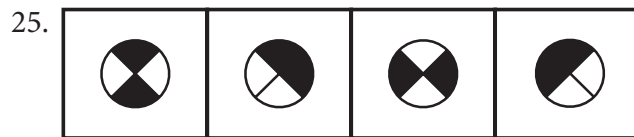
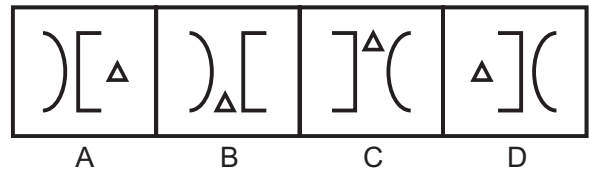
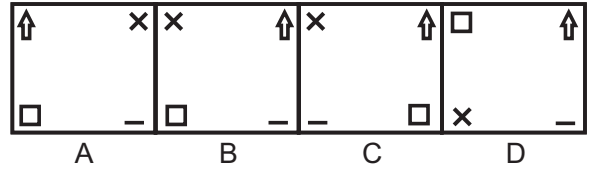
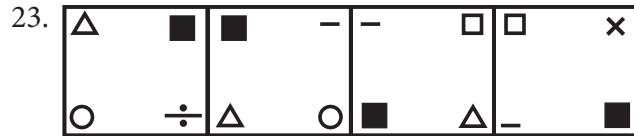
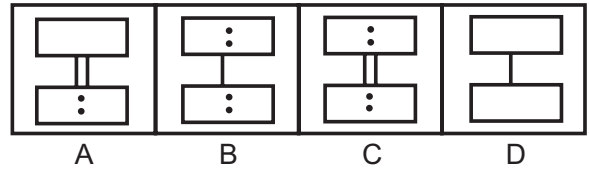
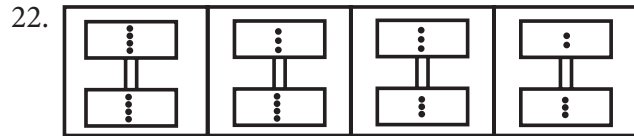

Problem Figures

Answer Figures

29.

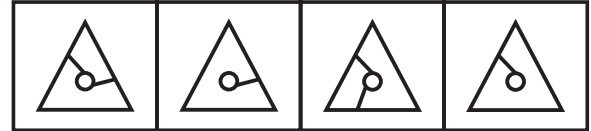
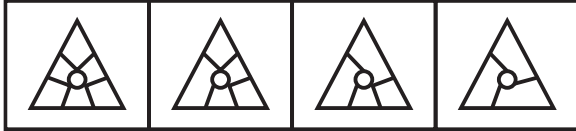

A

B

C

D

30.

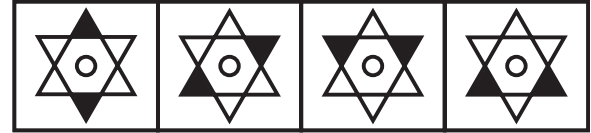
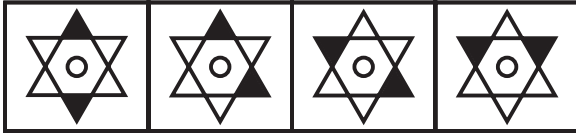

A

B

C

D

DO NOT START THE NEXT TEST UNTIL YOU ARE TOLD TO DO SO.

Tamanna: An Aptitude Test - VR

Instructions

Find the space for **VR-03** in your Answer Sheet. Answer all questions as directed.

This test consists of Part I and Part II.

PART I

Part I has 15 sentences (Questions 1-15). Each sentence has two pairs of words. One word from the second pair is missing. You need to complete the pair by selecting the correct word from the given options - A, B, C and D to make the statement correct and logical.

An example is given below:

Example X

Water is to **Tank** as **Money** is to _____

- A. Spend B. Bank C. Gold D. Manager

In the above example, the relationship between Water and Tank is that water is stored / saved in a tank. Similarly, money is saved in a bank. Therefore, the right answer is option "B". While marking answer "B" in the answer sheet, darken the circle of option B as shown below:

Correct way of marking the answer \Rightarrow (A) (B) (C) (D)

Practice Item

Ear is to **Hear** as **Eye** is to _____

- A. Light B. Capture C. See D. Picture

You are to mark the correct answer of the practice item in the answer sheet.

Answer:

PART II

Part II has 15 sentences (Questions 16-30). Each sentence has two pairs of words. The first word from the first pair and the last word from the second pair are missing. You need to select the word pair from the given options - A, B, C and D so that the sentence will be correct and logical.

The first word of the pair you choose goes to the first blank space in the sentence while the second word of the pair goes to the second blank space in the sentence.

Look at the following example:

Example Y

_____ is to **Red** as **Earth** is to _____

- A. Mars ----- Blue B. Jupiter ----- Orange
C. Mercury ----- Brown D. Saturn ----- Yellow

Mars is known as the 'Red Planet' because of its Red Soil and Earth is known as the 'Blue Planet' because of water in the oceans. Therefore, the answer is "A".

Practice Item:

_____ is to **Bird** as **Monkey** is to _____

- A. Wings ----- Branch B. Crow ----- Mammal
C. Crow ----- Branch D. Wings ----- Mammal

You are to mark the correct answer of the practice item in the answer sheet.

Answer:

You will have **10 minutes** for this test - Part I and II. Work as quickly as possible.

DO NOT MARK ANYTHING ON THIS BOOKLET.

PART I

1. **Word** is to **Dictionary** as **Map** is to _____
A. Globe B. Atlas C. Geography D. Location
2. **Thread** is to **Needle** as **Book** is to _____
A. Wood B. Rack C. Shelf D. Sack
3. **Wood** is to **Carpenter** as **Clay** is to _____
A. Potter B. Sculptor C. Architect D. Mason
4. **Skeleton** is to **Body** as **Grammar** is to _____
A. Sentence B. Language C. Education D. Meaning
5. **Flexible** is to **Rigid** as **Confident** is to _____
A. Coward B. Indifferent C. Hesitant D. Pessimistic
6. **Forecast** is to **Future** as **Regret** is to _____
A. Present B. Past C. Mistake D. Apology
7. **Contestant** is to **Competition** as **Witness** is to _____
A. Journey B. Trial C. Election D. Royalty
8. **Innumerable** is to **Quantity** as **Invaluable** is to _____
A. Size B. Surface C. Worth D. Volume
9. **Ice** is to **Igloo** as **Straw** is to _____
A. Hive B. Field C. Form D. Nest
10. **Train** is to **Station** as **Ship** is to _____
A. Harbour B. Sail C. Mast D. Anchor
11. **Comb** is to **Teeth** as **Book** is to _____
A. Page B. Word C. Knowledge D. Letter
12. **Appreciation** is to **Reward** as **Repentance** is to _____
A. Punishment B. Scold C. Complaint D. Regret
13. **Insulator** is to **Wood** as **Conductor** is to _____
A. Iron B. Cotton C. Plastic D. Pearl
14. **Breeze** is to **Cyclone** as **Rain** is to _____
A. Earthquake B. Storm C. Drizzle D. Flood
15. **Bridge** is to **River** as **Tunnel** is to _____
A. Road B. Passage C. Mountain D. Travel

PART II

16. _____ is to **Car** as **Water** is to _____
A. Road ----- Drink B. Road ----- Boat
C. Tyre ----- Boat D. Driver ----- Sailor
17. _____ is to **Justice** as **School** is to _____
A. Court----- Teacher B. Law ----- Education
C. Law----- Class D. Court ----- Education
18. _____ is to **Country** as **Governor** is to _____
A. President ----- State B. Flag ----- Nation
C. President ----- District D. Minister ----- State
19. _____ is to **Wheel** as **Blade** is to _____
A. Movement ----- Grass B. Air ----- Cut
C. Spokes ----- Fan D. Circle ----- Shave
20. _____ is to **Storm** as **Smoke** is to _____
A. Weather ----- Fire B. Thunder ----- Fire
C. Danger ----- Cooking D. Thunder ----- Cooking
21. _____ is to **Hand** as **Sock** is to _____
A. Glove ----- Feet B. Pencil ----- Feet
C. Glove ----- Shoe D. Ring ----- Toes
22. _____ is to **Chirp** as **Duck** is to _____
A. Snake ----- Quack B. Sparrow ----- Chatter
C. Frog ----- Quack D. Sparrow ----- Quack
23. _____ is to **Lion** as **Lamb** is to _____
A. Cub ----- Deer B. Kid ----- Deer
C. Cub ----- Sheep D. Kid ----- Sheep
24. _____ is to **Ocean** as **Elephant** is to _____
A. Fish ----- Earth B. Whale ----- Desert
C. Fish ----- Land D. Whale ----- Land

25. _____ is to **Country** as **Frame** is to _____
- A. Border ----- Colour B. Border ----- Picture
 C. Capital ----- Picture D. Capital ----- Colour
26. _____ is to **Wood** as **Tailor** is to _____
- A. Carpenter ----- Cloth B. Plumber ----- Sewing
 C. Table ----- Cloth D. Carpenter ----- Sewing
27. _____ is to **Stable** as **Dog** is to _____
- A. Horse ----- Shed B. Cow ----- House
 C. Cow ----- Kennel D. Horse ----- Kennel
28. _____ is to **Thick** as **Silence** is to _____
- A. Bold ----- Loud B. Bold ----- Noise
 C. Thin ----- Noise D. Thin ----- Loud
29. _____ is to **Weather** as **Cardiology** is to _____
- A. Meteorology ----- Heart B. Radiology ----- Teeth
 C. Meteorology ----- Eyes D. Radiology ----- Skin
30. _____ is to **Porous** as **Rubber** is to _____
- A. Glass ----- Elastic B. Sponge ----- Elastic
 C. Sponge ----- Solid D. Glass ----- Solid

DO NOT START THE NEXT TEST UNTIL YOU ARE TOLD TO DO SO.

Tamanna: An Aptitude Test - MR

Instructions

Find the space for **MR-04** in your Answer Sheet. Answer all questions as directed.

In this test, there are 30 items. All items have questions along with figures like those given in the example below. Read each question carefully, look at the figures and find the correct answer from the four options- A, B, C and D.

Look at the example given below:

Example X

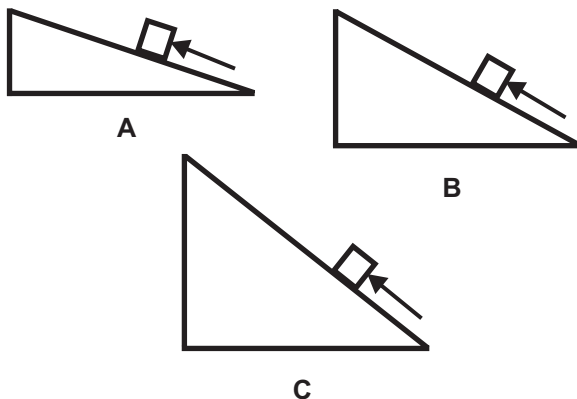

A wooden block is pushed upwards by applying force as shown in figures A, B and C. In which figure, the force needed to be applied would be maximum?

- A. Figure A
- B. Figure B
- C. Figure C
- D. Equal force in all situations

In this example, the slope of the inclined plane is maximum in C. Therefore, it would require more force. The right answer is C. Darken the circle of option C in the answer sheet as shown below:

Correct way of marking the answer \Rightarrow A B C D

Practice Item

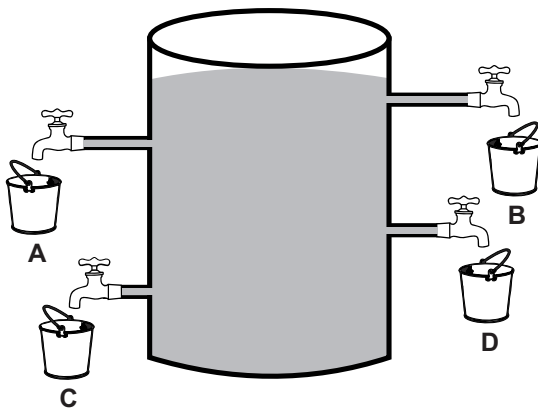

In the given figure which one of the buckets will get filled first?

- A. Bucket A
- B. Bucket B
- C. Bucket C
- D. Bucket D

You are to mark the correct answer of the practice item in the answer sheet.

Answer: C

You will have **10 minutes** for this test. Work as quickly as possible.

DO NOT MARK ANYTHING ON THIS BOOKLET.

1.

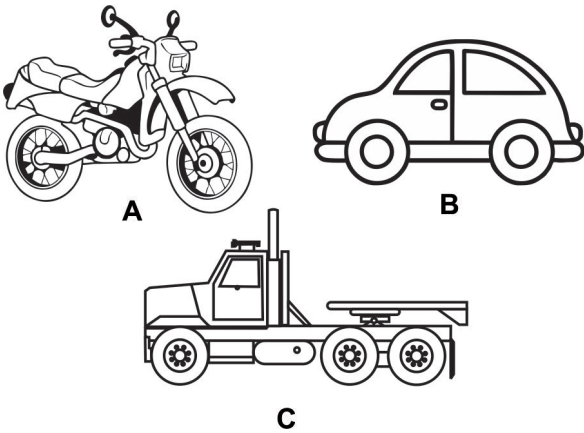

A motorcycle, a car and a truck are moving with equal momentum. Which one has the greatest kinetic energy?

- A. Motorcycle
- B. Car
- C. Truck
- D. All have same kinetic energy

2.

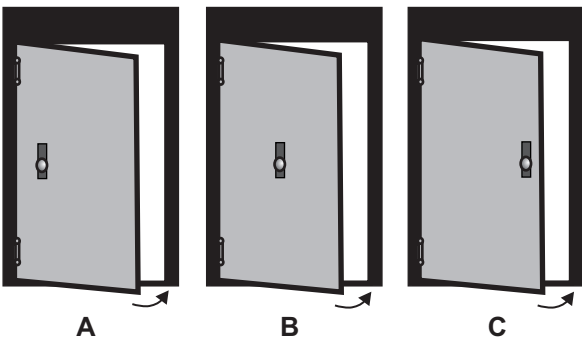

The handles on doors A, B and C are placed in different positions as shown. Using the handle, which door would be closed by applying minimum force?

- A. Door A
- B. Door B
- C. Door C
- D. Same force in all

3.

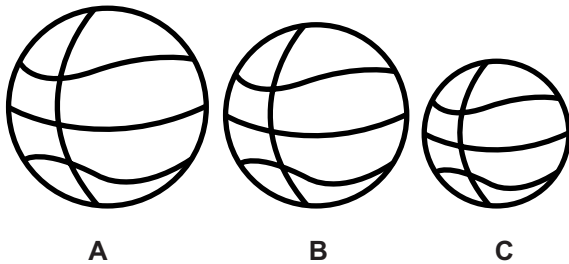

Three balls A, B and C of same mass are dropped together in vacuum from a height of 6 meters. Which ball would reach first on the floor?

- A. Ball A
- B. Ball B
- C. Ball C
- D. All the balls at the same time

4.

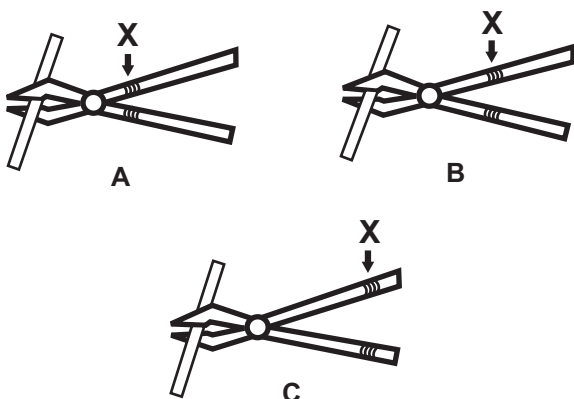

In which one of the given figures, the force is required to cut the wire will be minimum if force is applied at X?

- A. Figure A
- B. Figure B
- C. Figure C
- D. Equal force in all cases

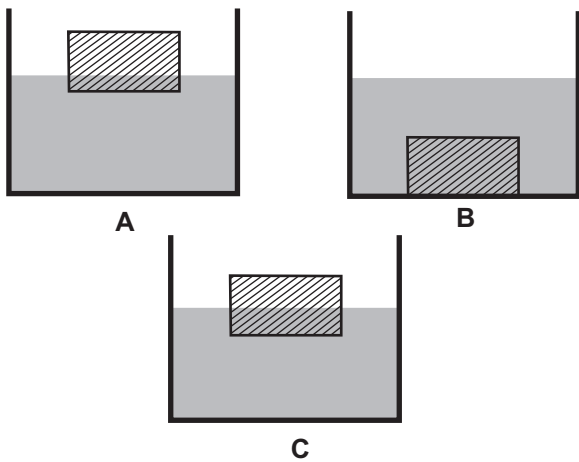

5.

Which of the given containers shows the heaviest object?

- A. Container A
- B. Container B
- C. Container C
- D. All objects have same weight

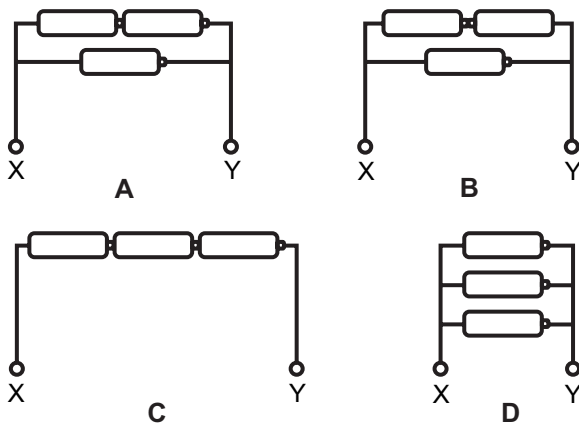

6.

Three cells of 1.5V each are connected in four different ways as shown. Which arrangement will give 4.5V between points X and Y?

- A. Figure A
- B. Figure B
- C. Figure C
- D. Figure D



7.

Which direction should the screw shown in the figure be turned in order to tighten it into place?

- A. Clockwise
- B. Anti-clockwise
- C. Either clockwise or anti-clockwise
- D. Screw cannot be tightened

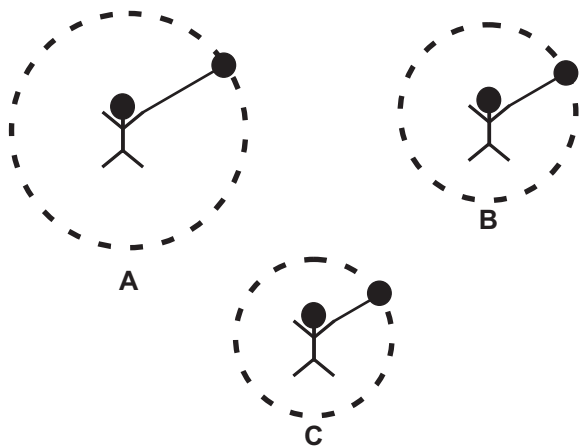

8.

Three persons in the figures are turning around a solid ball tied to a rope and making same number of rotations per second. If suddenly the rope is released, which one will fall at the maximum distance?

- A. Person A
- B. Person B
- C. Person C
- D. All will fall at the same distance

9.

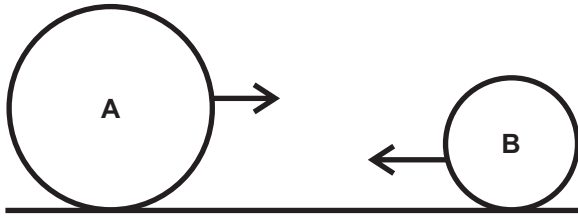

Two balls A and B, with different sizes but same density are rolling with the same speed and are moving towards each other to collide. What would happen to ball A after the collision?

- A. Ball A will stop
- B. Ball A will jump over the smaller ball B
- C. Ball A will start moving backward
- D. Ball A will keep moving forward

10.

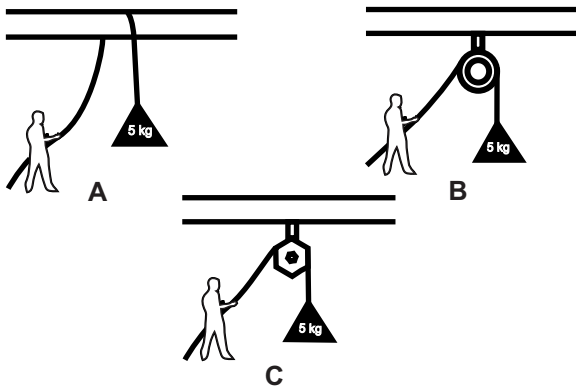

A man is lifting a mass of 5 kg. In which of the given figures, does he apply the minimum force?

- A. Figure A
- B. Figure B
- C. Figure C
- D. Equal force in all

11.

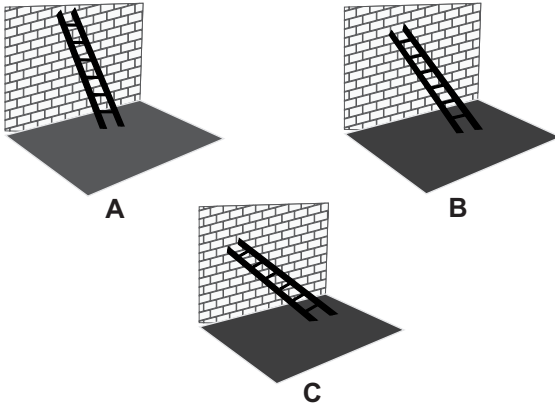

In which of the given pictures, will the ladder be least stable or most likely to slip?

- A. Picture A
- B. Picture B
- C. Picture C
- D. Equal chance in all cases

12.

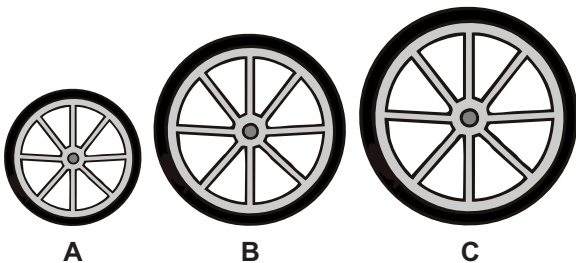

Three wheels A, B and C cover the same distance in same time. Which wheel rotates the fastest?

- A. Wheel A
- B. Wheel B
- C. Wheel C
- D. All wheels will rotate at the same rate

13.

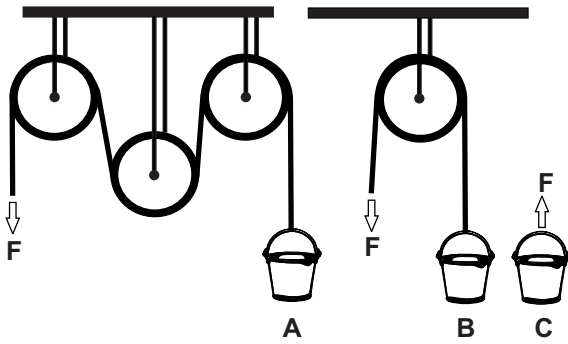

In which of the given situations, the force F needed to lift a bucket of water is the least?

- A. Situation A
- B. Situation B
- C. Situation C
- D. Equal force in all situations

14.

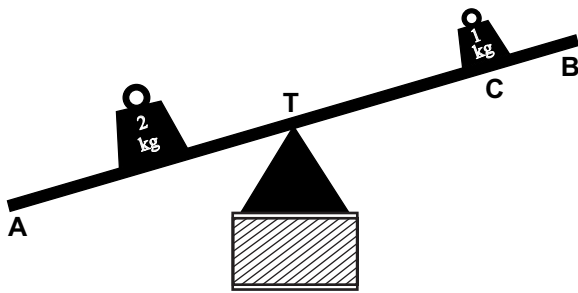

Where should the smaller weight be shifted from C to balance the beam on fulcrum at T?

- A. Towards the fulcrum
- B. Away from the fulcrum
- C. By lifting up
- D. Cannot be done

15.

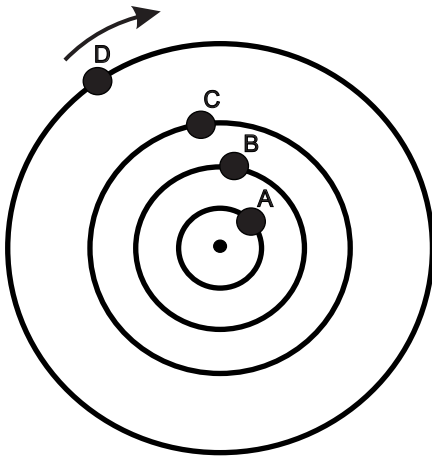

In a rotating horizontal disc, which point will be at the fastest speed?

- A. Point A
- B. Point B
- C. Point C
- D. Point D

16.

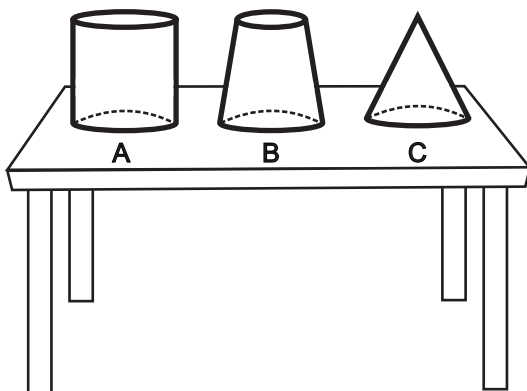

Which object is most likely to fall over first when the table is shaken/disturbed?

- A. Object A
- B. Object B
- C. Object C
- D. All objects will fall together

17.

In the pipe given, at which point will the fluid have the maximum speed?

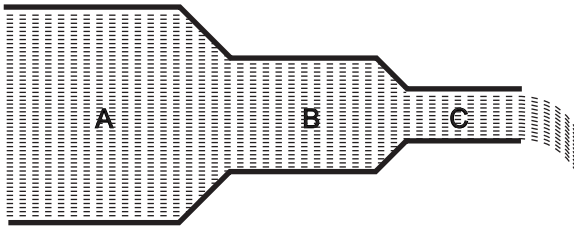

- A. Point A
- B. Point B
- C. Point C
- D. Speed is same at all points

18.

A solid ball is dropped from a height 'h'. After it has fallen half of the distance, it possesses

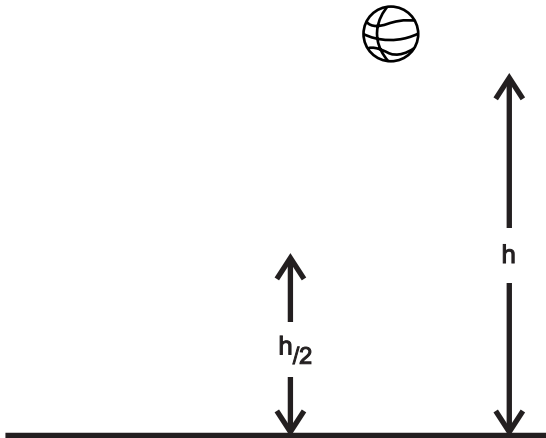

- A. Only kinetic energy
- B. Only potential energy
- C. Half potential energy and half kinetic energy
- D. More kinetic energy less and potential energy

19.

In which of the given figures, a lactometer would indicate the maximum water impurity in milk?

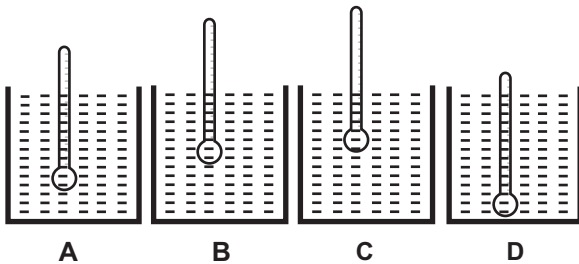

- A. Figure A
- B. Figure B
- C. Figure C
- D. Figure D

20.

Look at the given pictures of three ballet dancers. Which one of them is likely to rotate at the highest speed?

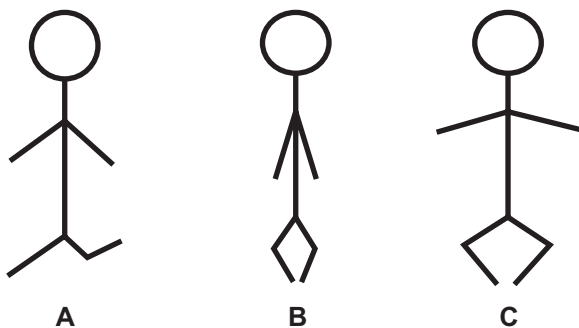

- A. Dancer A
- B. Dancer B
- C. Dancer C
- D. All dancers rotate at the same speed

21.

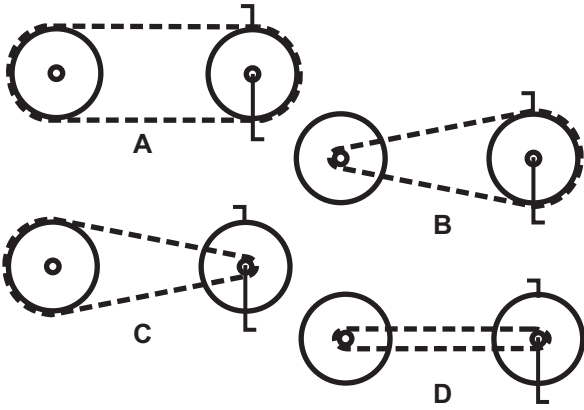

In which of the given figures, will the force required to rotate the wheel is maximum?

- A. Figure A
- B. Figure B
- C. Figure C
- D. Figure D

22.

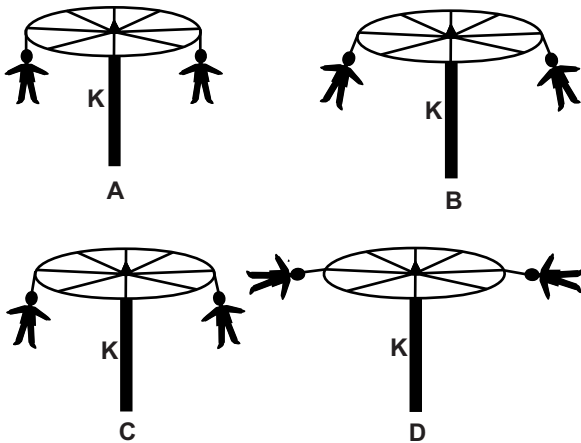

Two dolls are tied on the rim of a rotating wheel. Which one of the given wheels is turning the fastest due to rotation of the handle at K?

- A. Wheel A
- B. Wheel B
- C. Wheel C
- D. Wheel D

23.

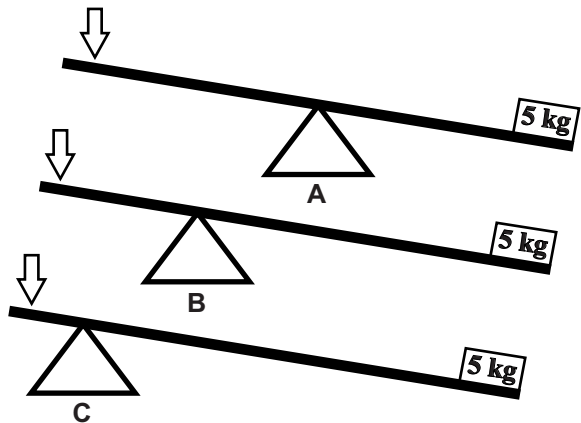

In which one of the given figures, minimum force will be required to lift 5 kg?

- A. Figure A
- B. Figure B
- C. Figure C
- D. Same force in all

24.

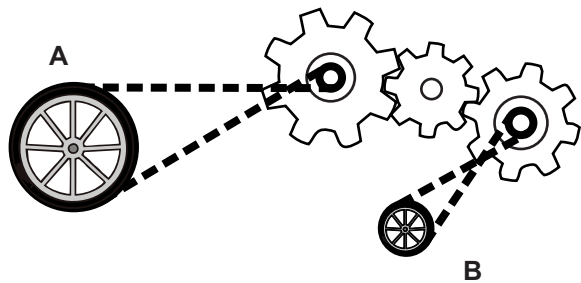

If wheel B moves anti-clockwise at a certain speed 'p' rotations/second, how does wheel A move?

- A. Clockwise, same speed
- B. Anti-clockwise, slower than 'p'
- C. Anti-clockwise, same speed
- D. Clockwise, slower than 'p'

25.

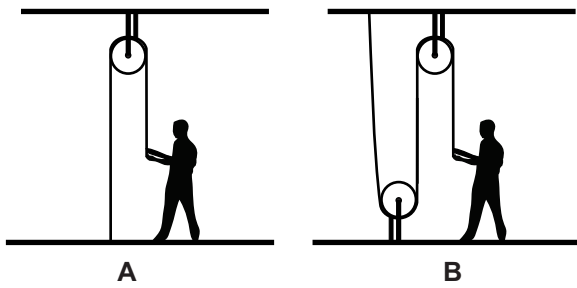

You are standing on a platform connected to a pulley shown in the figure. Which of the following will be the easiest way to lift you up?

- A. Pulley A
- B. Pulley B
- C. Same in both
- D. Not possible to lift

26.

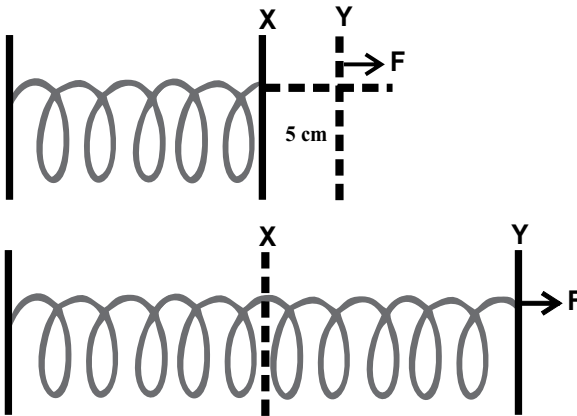

A given spring is extended by 5 cm when pulled by a force F . Now two such springs are connected as shown in the figure. What will be the extension produced in this combination of springs by the same force?

- A. 5 cm
- B. 2.5 cm
- C. 10 cm
- D. 7.5 cm

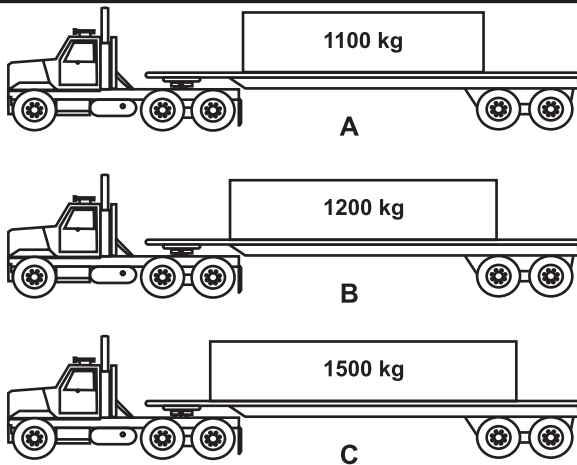

27.

Trucks A, B and C hit a wall with the same speed. Which truck would cause most damage to the wall?

- A. Truck A
- B. Truck B
- C. Truck C
- D. All will cause equal damage

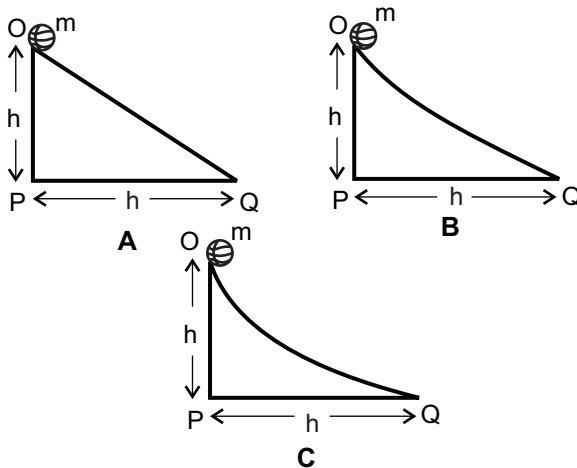

28.

Three identical balls each of mass ' m ' are released simultaneously on three incline surfaces from the same height. In which of the following cases, the ball will reach the point Q first?

- A. A
- B. B
- C. C
- D. All will reach at the same time

29.

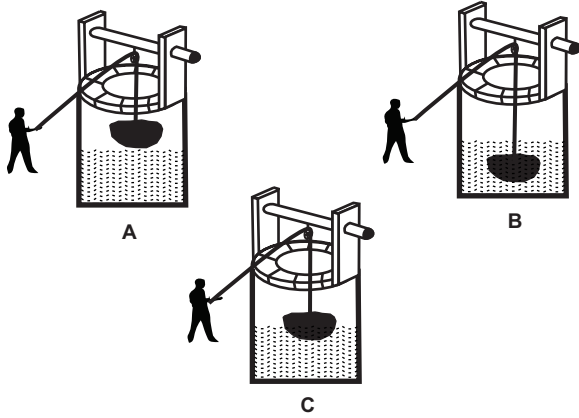

In which of the given situation, will the stone be felt the lightest by the person holding it?

- A. Situation A
- B. Situation B
- C. Situation C
- D. Equal weight in all three situations

30.

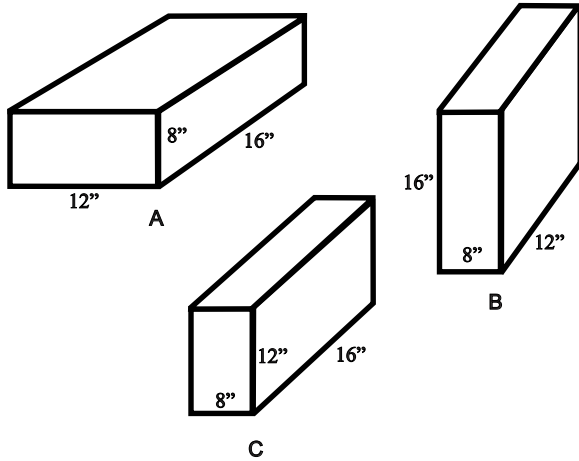

Which of the given boxes will exert maximum pressure on the floor?

- A. Box A
- B. Box B
- C. Box C
- D. All boxes will exert the same pressure

DO NOT START THE NEXT TEST UNTIL YOU ARE TOLD TO DO SO.

Tamanna: An Aptitude Test - NA

Instructions

Find the space for **NA-05** in your Answer Sheet. Answer all questions as directed.

This test consists of 30 arithmetical problems, some of which are numerical and some are word problems. Each problem is followed by four given options- A, B, C and D. You are to choose the correct answer and mark it in your answer sheet. Do calculations if any, on a Rough Sheet.

The following two questions have been solved for you as examples.

Example X

What will come in place of ‘?’ in the following question ?

$$4656 + 1244 = ?$$

- A. 6000 B. 5950 C. 5900 D. 7600

Adding 4656 and 1244 together, we get 5900.

In this example, right answer is “C”, therefore, darken the circle of option C as shown below:

Correct way of marking the answer \Rightarrow (A) (B) ● (D)

Example Y

What is the value of five times of square of 2 ?

- A. 10 B. 20 C. 4 D. 16

The value of five times of square of 2 gives us the answer as 20.

In this example, right answer is “B”, therefore, darken the circle of option B as shown below:

Correct way of marking the answer \Rightarrow (A) ● (C) (D)

Practice Items

1. $1373 + 2841 + 2254 = ?$

- A. 6368 B. 5468 C. 6468 D. 6458

Answer:

2. A bucket has a capacity of 11 litres. How many buckets of water are required to fill a tank having capacity of 121 litres ?

- A. 10 B. 11 C. 15 D. 13

You are to mark the correct answer of the practice items in the answer sheet.

Answer:

You will have **10 minutes** for this test. Work quickly and solve as many problems as you can.

DO NOT MARK ANYTHING ON THIS BOOKLET.

1. $\frac{3}{5} - \frac{2}{5} = ?$
A. $\frac{1}{25}$ B. $-\frac{1}{5}$ C. $\frac{1}{5}$ D. $\frac{6}{25}$
2. $\frac{?}{24} = \frac{6}{18}$
A. 8 B. 3 C. 72 D. 12
3. $\sqrt{5.76} = ?$
A. 2.4 B. 4.2 C. 0.24 D. 0.26
4. Let $x : y = 2 : 5$ What is the value of $x : y$ in percentage ?
A. 60% B. 0.4% C. 40% D. 0.6%
5. Which one of the following has value 1 ?
A. $\frac{(-3) \times 2}{6}$ B. $\frac{(-6)}{(-2) \times (-3)}$ C. $\frac{2 \times (-3)}{6}$ D. $\frac{6}{(-3) \times (-2)}$
6. What is the next number in following number sequence ?
2400, 1200, 600, 300, ?
A. 0 B. 100 C. 150 D. 200
7. $\sqrt[3]{216} = ?$
A. 72 B. 27 C. 6 D. 7
8. $0.023 \times 0.23 = ?$
A. 0.00529 B. 5.29 C. 0.0529 D. 0.529
9. $\frac{1}{3} \div \frac{1}{9} = ?$
A. $\frac{1}{9}$ B. $\frac{1}{27}$ C. 9 D. 3
10. $38 = 19\%$ of (?)
A. 20 B. 200 C. 300 D. 2000

11. What is the next number in following number sequence ?
 $\sqrt{100}$, 9, $\sqrt{64}$, 7, ?
- A. 5 B. $\sqrt{36}$ C. $\sqrt{28}$ D. 8
12. If $x = 10$ then $3x^2 - x = ?$
- A. 50 B. 200 C. 270 D. 290
13. What is 710×80 rounded to nearest thousand ?
- A. 50000 B. 55000 C. 57000 D. 60000
14. $\sqrt[3]{\frac{1}{8} \times \frac{125}{64}} = ?$
- A. $\frac{5}{8}$ B. $\frac{125}{512}$ C. $2\frac{1}{2}$ D. $15\frac{5}{8}$
15. Which of the following number is exactly divisible by 3 ?
- A. 766 B. 768 C. 796 D. 976
16. $mn = y$ if $y = 10$, then $m = ?$
- A. $10-n$ B. $n-10$ C. $\frac{n}{10}$ D. $\frac{10}{n}$
17. $(3.1)^3 = ?$
- A. 9.313 B. 9.213 C. 29.791 D. 29.971
18. Which of the following is the smallest number that is exactly divisible by 2, 4, 7, and 21 ?
- A. 76 B. 168 C. 84 D. 42
19. Find the value of (?)
- $(12)^2 + (5)^2 + (3)^3 = (?)^2$
- A. 16 B. 24 C. 14 D. 26
20. What is the next number in following number sequence ?
- 8, 27, 64, 125, ?
- A. 216 B. 196 C. 169 D. 225

21. $\left[(6^3)^{\frac{1}{3}} + (8^2)^{\frac{1}{2}} \right]^2 = ?$
 A. 196 B. 169 C. $(100)^2$ D. $(102)^2$
22. What is $\frac{84.189 \times 1.99}{6.889}$ rounded to nearest whole number ?
 A. 28 B. 24 C. 20 D. 25
23. $a = \frac{1}{2} bh$ If $b = 6$ and $a = 14$, then $h = ?$
 A. $\frac{14}{3}$ B. $\frac{7}{3}$ C. $\frac{7}{6}$ D. $\frac{6}{7}$
24. Which one of the following has a sum greater than 1 ?
 A. $\frac{1}{5} + \frac{3}{4}$ B. $\frac{2}{3} + \frac{3}{8}$ C. $\frac{8}{12} + \frac{1}{3}$ D. $\frac{5}{8} + \frac{1}{4}$
25. Three qualities of sugar costing Rs. 22/kg, Rs. 25/kg and Rs. 30/kg are mixed in the ratio 1 : 2 : 3 respectively. What is the cost of the resultant mixture per kg ?
 A. Rs 24/kg B. Rs 25/kg C. Rs 34/kg D. Rs 27/kg
26. Currently, my age is 11 times that of my daughter. In 4 years my age would be 6 times that of my daughter's age. What is my current age ?
 A. 22 years B. 63 years C. 44 years D. 33 years
27. $\sqrt{9^2 + 5^2 + 38} = ?$
 A. 24 B. 8 C. 18 D. 12
28. $999.99 - 99.99 + 9999 = ?$
 A. 10899.99 B. 11899 C. 11899.99 D. 10899
29. $(0.5 \times 0.625) \div 25 = ?$
 A. 0.25 B. 0.0125 C. 0.125 D. 0.025
30. The product of two numbers is 56 and the sum of these two numbers is 15. Find these two numbers.
 A. 9 and 6 B. 14 and 4 C. 8 and 7 D. 7 and 9

DO NOT START THE NEXT TEST UNTIL YOU ARE TOLD TO DO SO.

Tamanna: An Aptitude Test - SA

Instructions

Find the space for SA-06 in your Answer Sheet. Answer all questions as directed.

This test consists of Part I and Part II.

PART I

Part I has 20 items (Questions 1-20). Read instructions given at the top of each page carefully. Each item consists of a Problem Figure followed by Answer Figures. Each Answer Figure has four options- A, B, C and D. Only one among them is right answer. Select the right answer.

Look at the following example:

Example X

Find out which options- A, B, C and D from the Answer Figure has parts that can make the Problem Figure.

Problem Figure

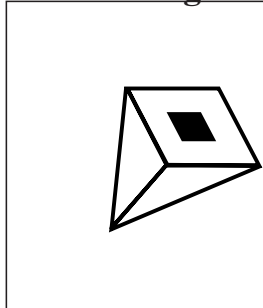

Answer Figure

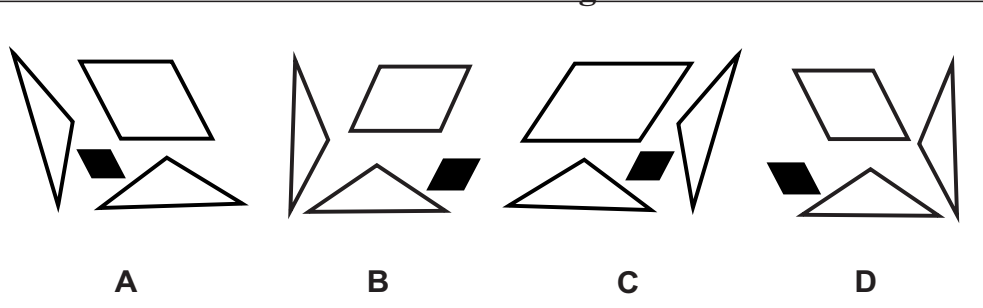

When we arrange the parts given in the Answer Figure, only option "A" correctly forms the Problem Figure. Therefore, option "A" is the right answer. Darken the circle of option A in the answer sheet as shown below:

Correct way of marking the answer \Rightarrow ● (B) (C) (D)

Practice Item

Find out which options- A, B, C and D from the Answer Figure has parts that can make the Problem Figure.

Problem Figure

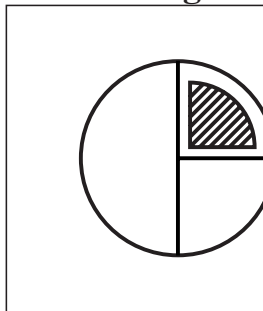

Answer Figure

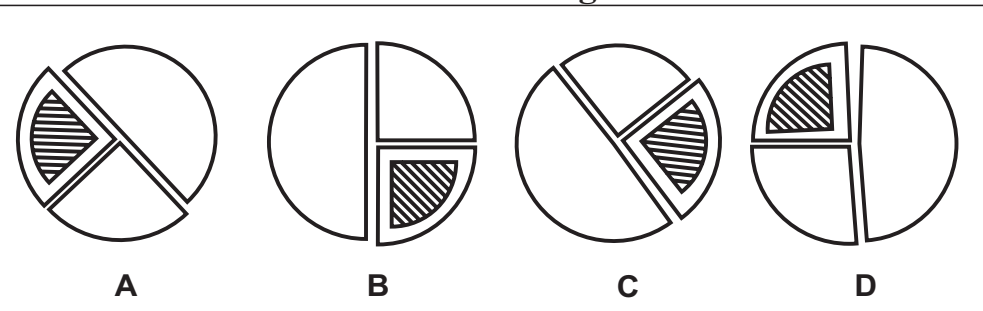

You are to mark the correct answer of the practice item in your answer sheet.

Answer: B

You will have **10 Minutes** for this test Part I, and II. Work as quickly as possible.

DO NOT MARK ANYTHING ON THIS BOOKLET.



PART I

INSTRUCTION : Find out which parts given in Answer Figure A, B, C and D when combined will look like/make up the Problem Figure.

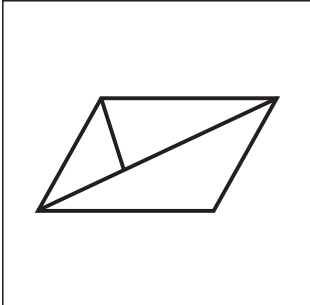
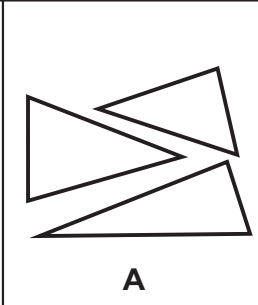
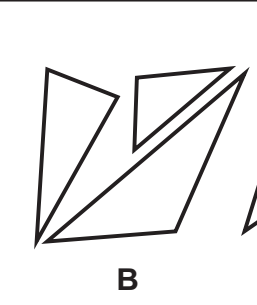
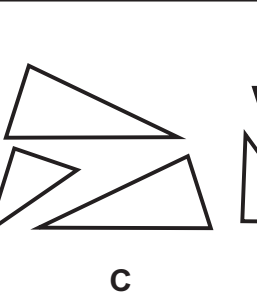
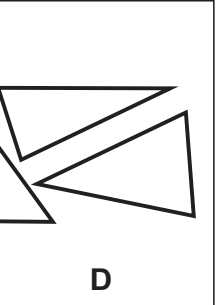
1. **Problem Figure** **Answer Figures**

2.

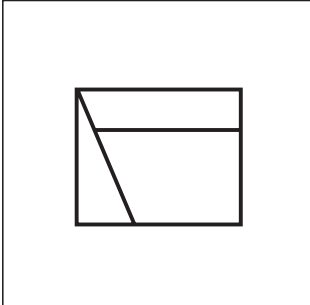
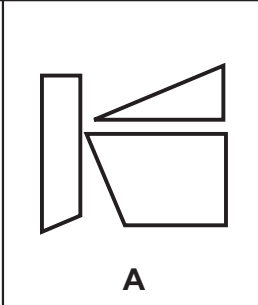
3.

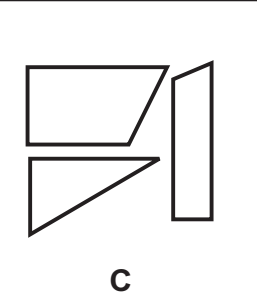
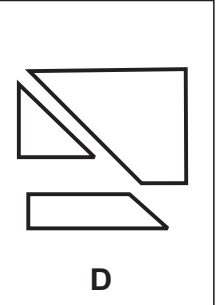
4.

5.

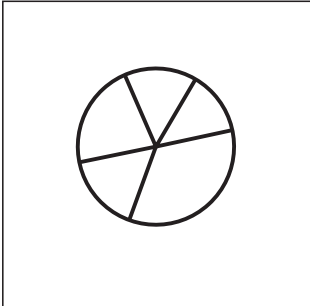
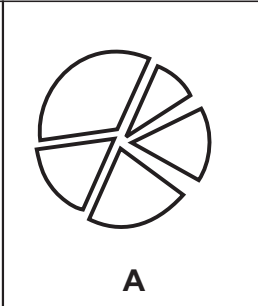
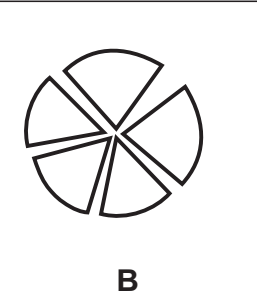
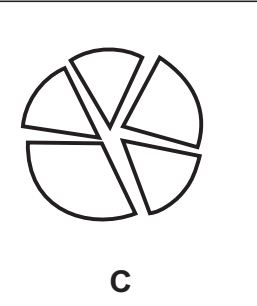
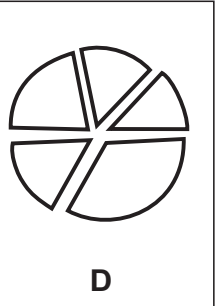

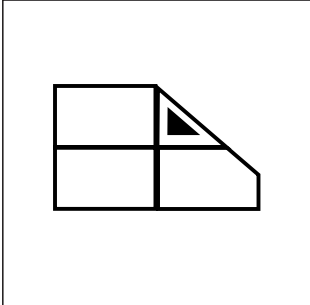
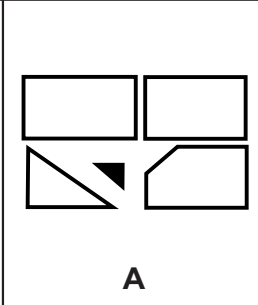
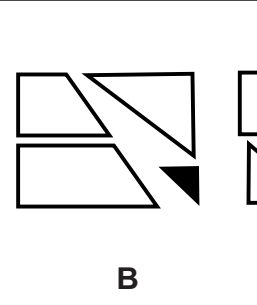
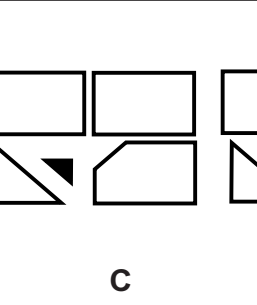
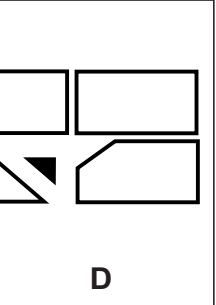

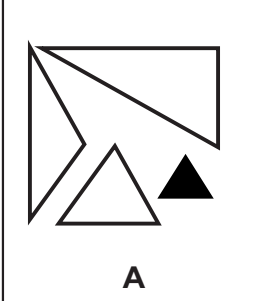
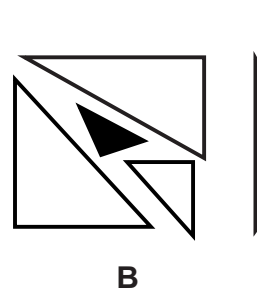
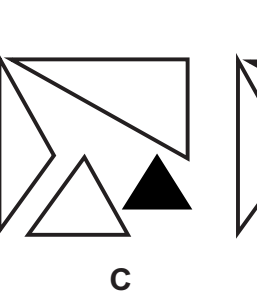
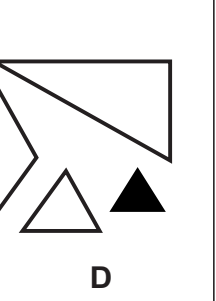

INSTRUCTION : Find out which of the Answer Figure A, B, C and D will be formed from the parts given in Problem Figure.

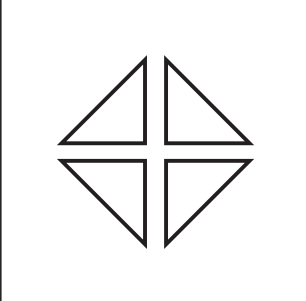
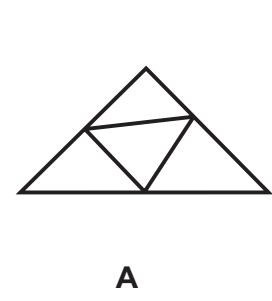
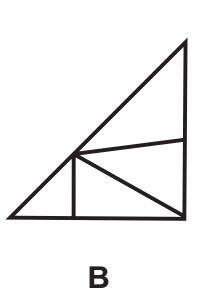
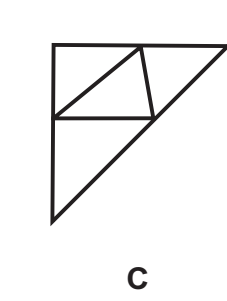
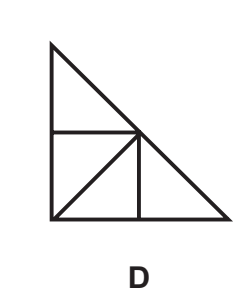
Problem Figure

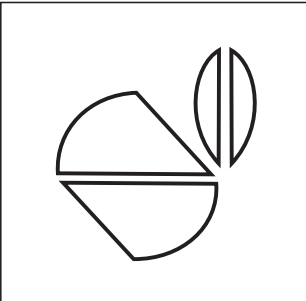
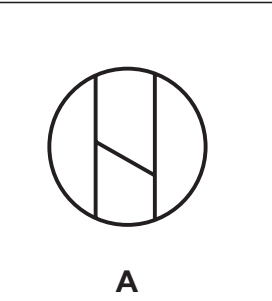
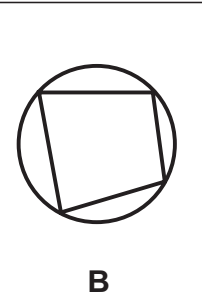
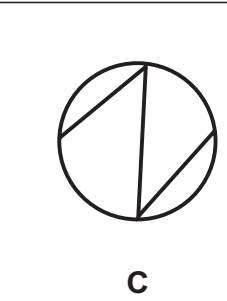
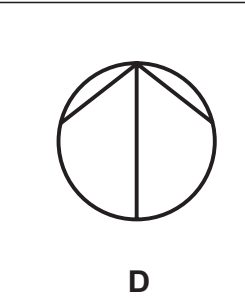

Answer Figures

6.     

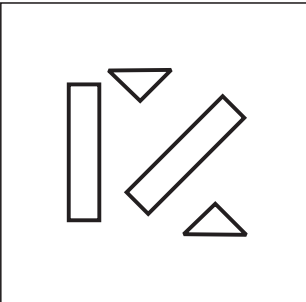
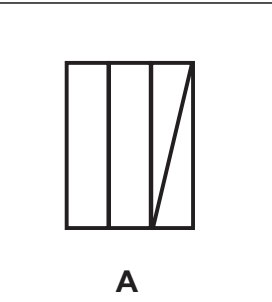
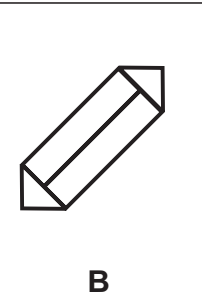
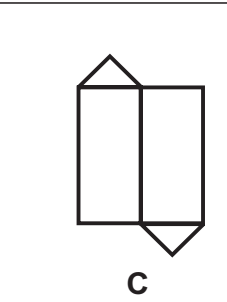
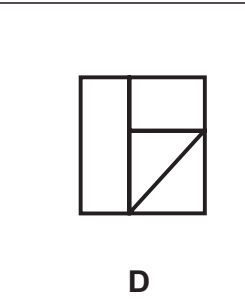
7.     

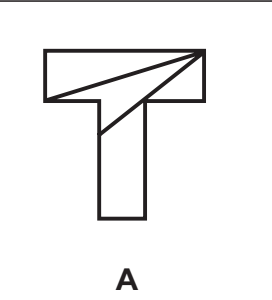
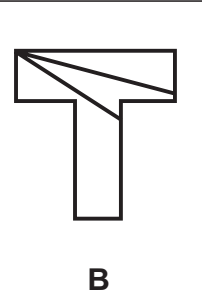
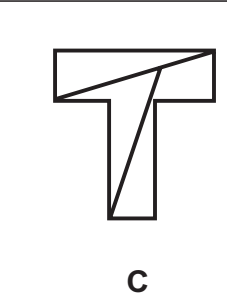
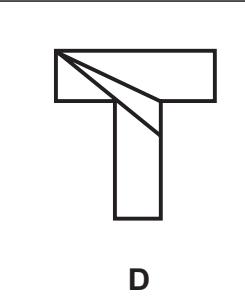
8.     

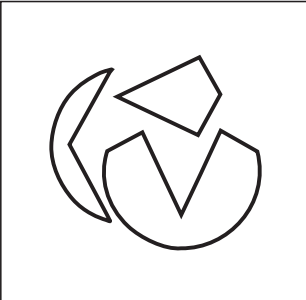
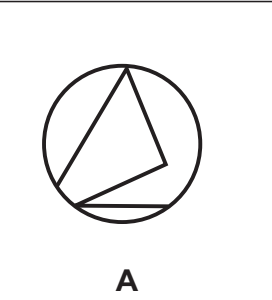
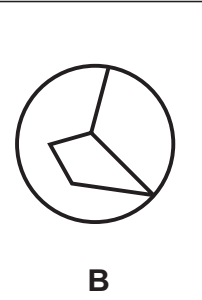
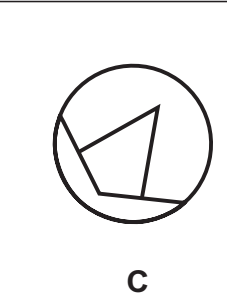
9.     

10.     

INSTRUCTION : If the Problem Figure is rotated anti-clockwise at 90°, which of the Answer Figures among options- A, B, C and D will it look like.

Problem Figure

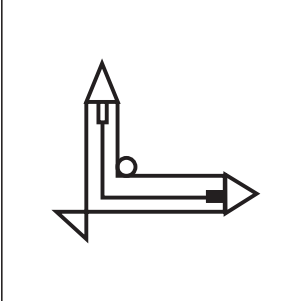
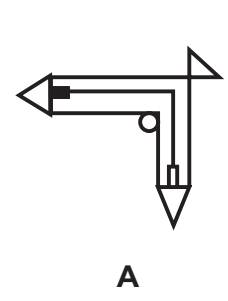
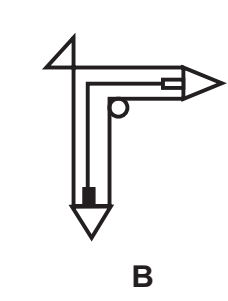
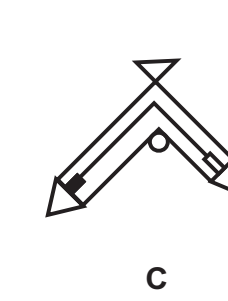
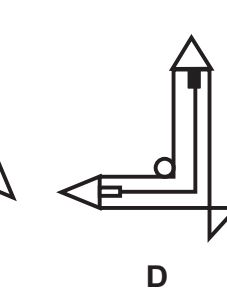

Answer Figures

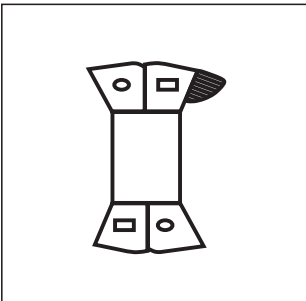
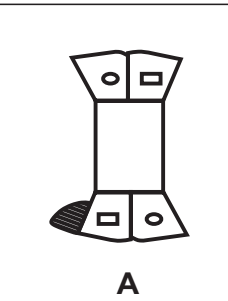
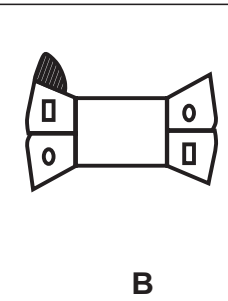
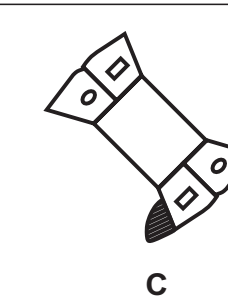
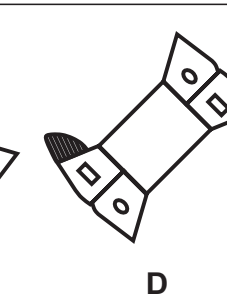
11.     

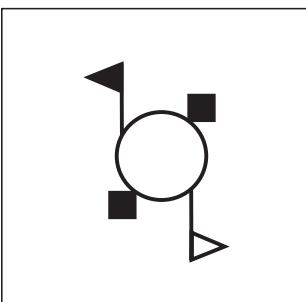
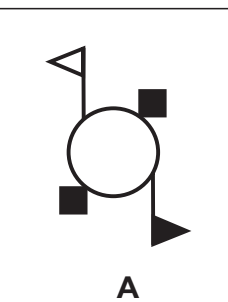
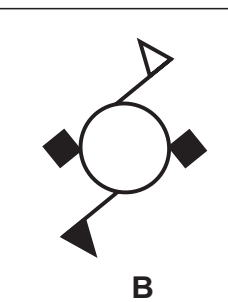
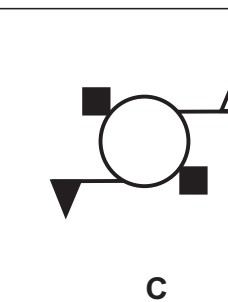
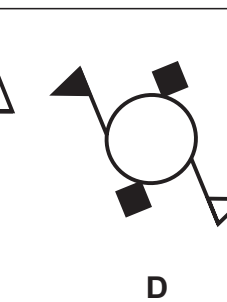
12.     

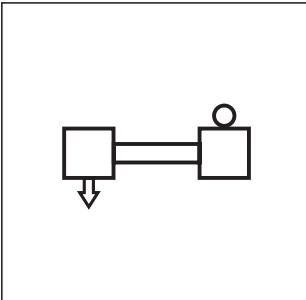
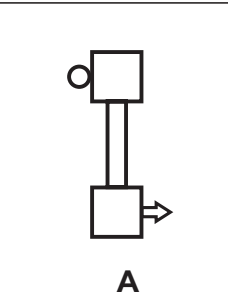
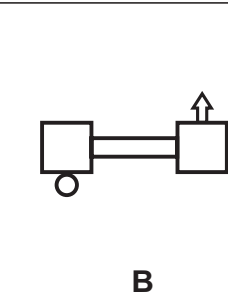
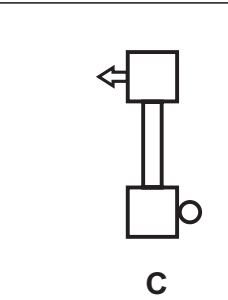
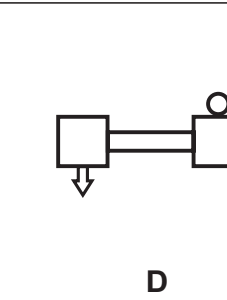
13.     

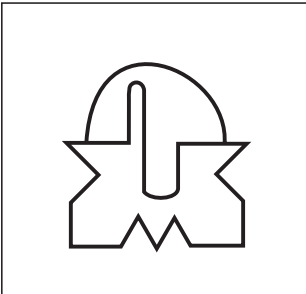
14.     

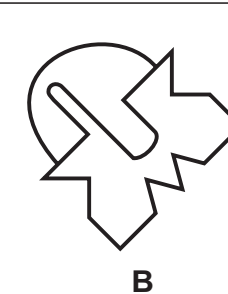
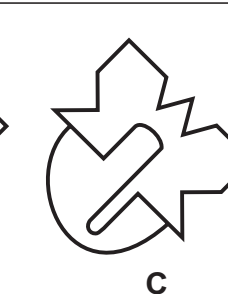
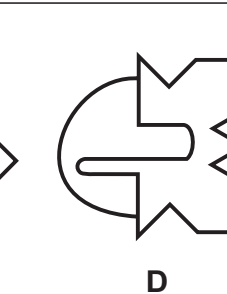
15.     

Now let us understand the following example

Look at the Problem Figure and see how the options are same and only **turned around** in different ways.

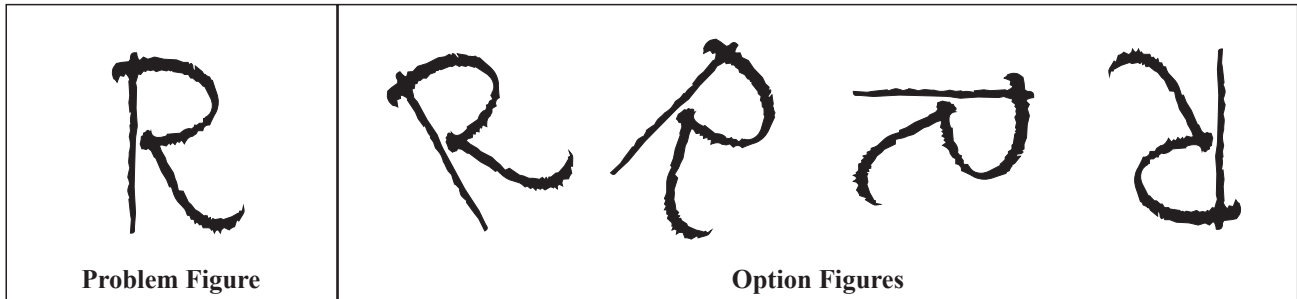

Here, at the Problem Figure see how the options are **Flipped Over and turned around** in different ways.

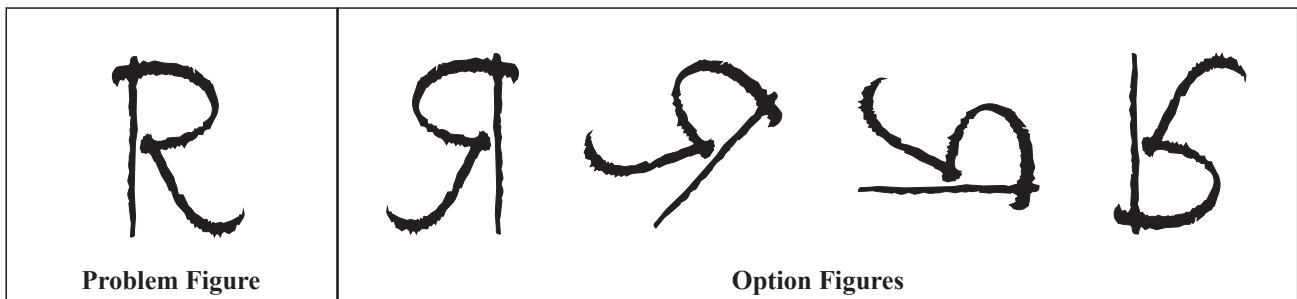

INSTRUCTION : In the Answer Figures given below, three options are Flipped Over and turned around. One of them is Same as the Problem Figure but is only turned around. Find the figure which is Same as the Problem Figure and is only turned around.

Problem Figure

Answer Figures

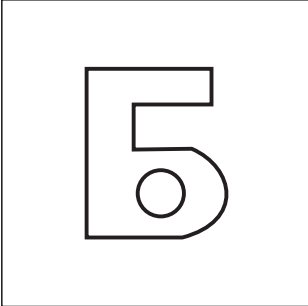
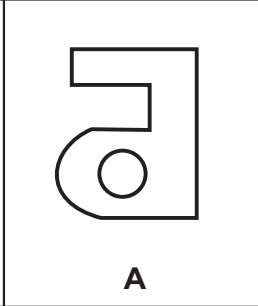
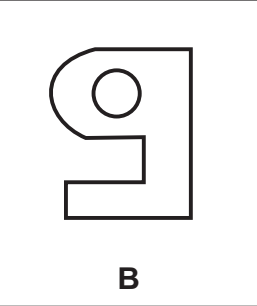
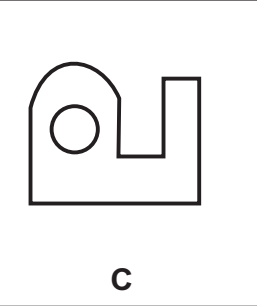
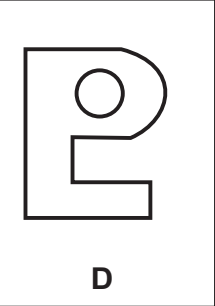
16.     

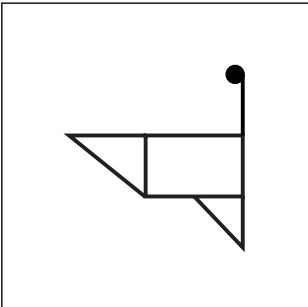
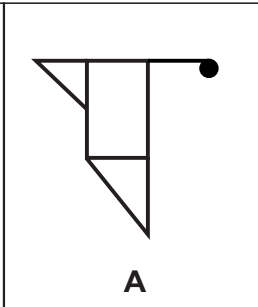
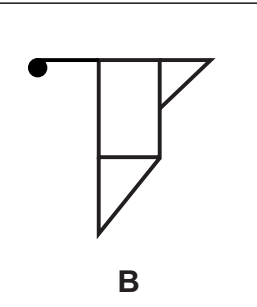
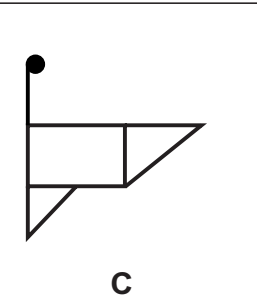
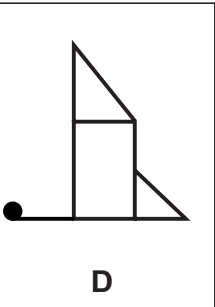
17.     

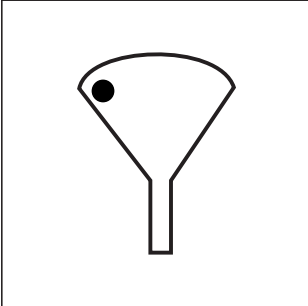
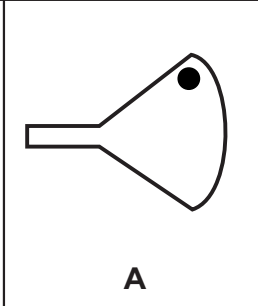
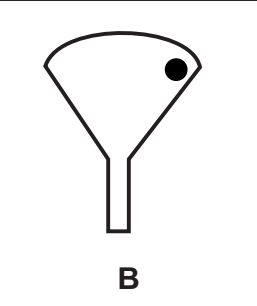
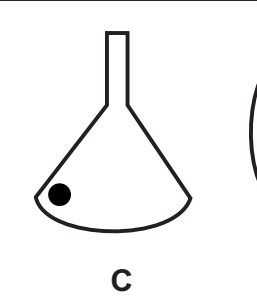
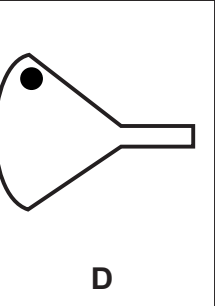
18.     

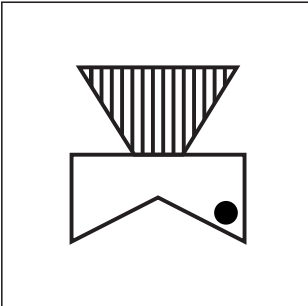
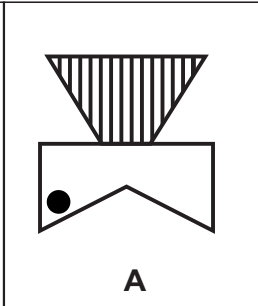
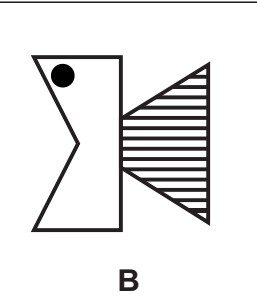
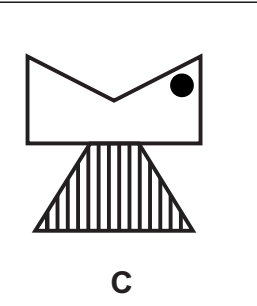
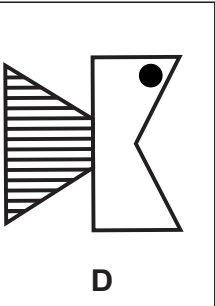
19.     

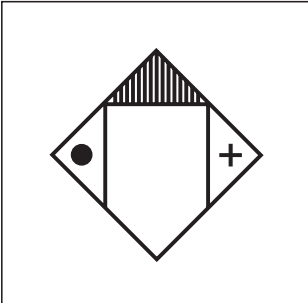
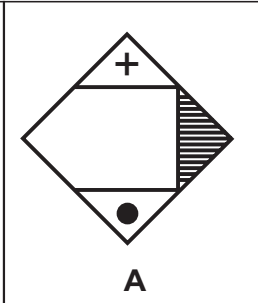
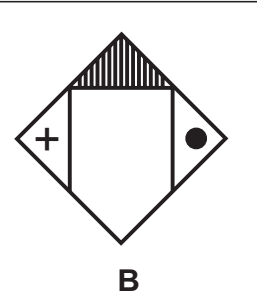
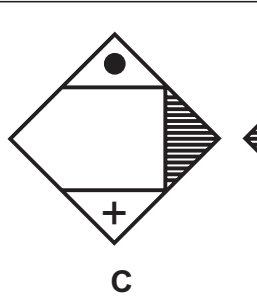
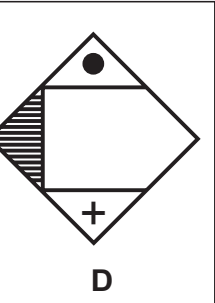
20.     

PART II

Part II has 10 items (Questions 21-30). Each item has a Problem Figure followed by Answer Figures. You are required to imagine how the Problem Figure will look like when it is folded. Choose from the options given in the Answer Figures- A, B, C and D. Only one among the suggested options is correct.

Look at the following example:

Example Y

Problem Figure

Answer Figure

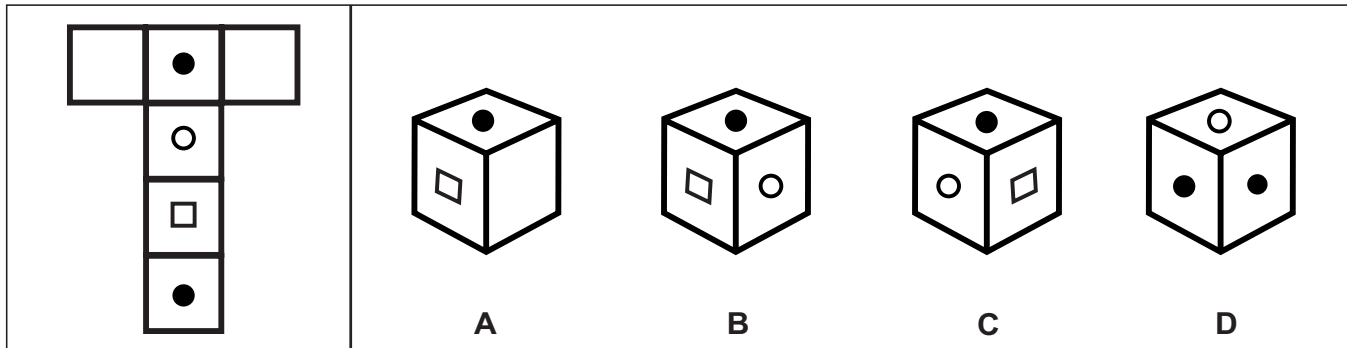

When the Problem Figure is folded such that the bottom most side (with a dot) is at the top then the side above it (which has a small square on it) will be visible in front and the side (with no pattern on the outside) will be on the right side. Thus option “A” is the most appropriate option. Darken the circle of option A in the answer sheet as shown below:

Correct way of marking the answer → ● (B) (C) (D)

Practice Item:

Problem Figure

Answer Figure

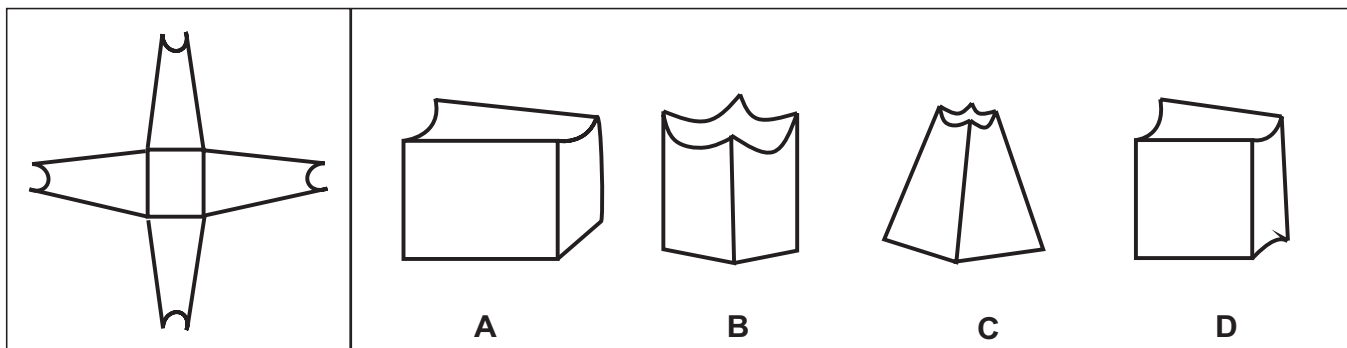

You are to mark the correct answer of the practice item in your answer sheet.

Answer: C

DO NOT MARK ANYTHING ON THIS BOOKLET.

PART II

Problem Figure

Answer Figures

21.

	A	B	C	D

22.

	A	B	C	D

23.

	A	B	C	D

24.

	A	B	C	D

25.

	A	B	C	D

Problem Figure

Answer Figures

26.

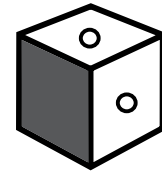
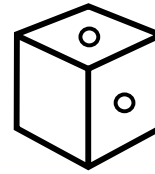
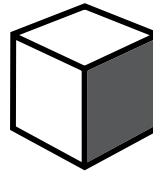
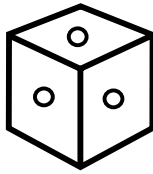
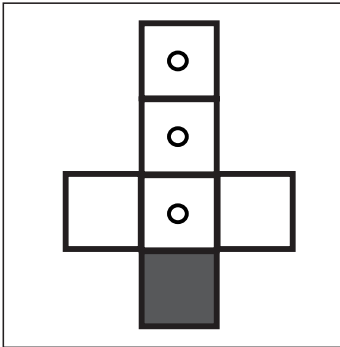

A

B

C

D

27.

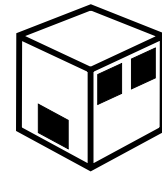
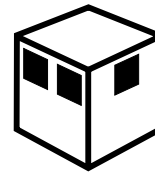
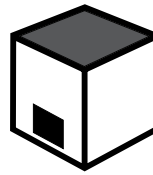
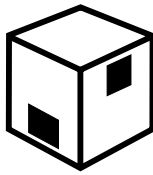
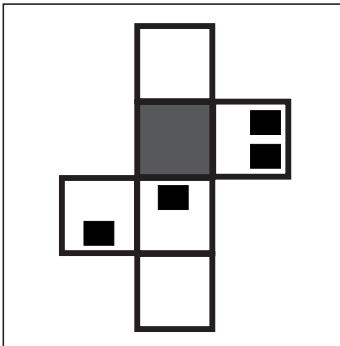

A

B

C

D

28.

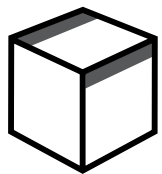
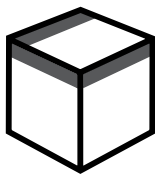
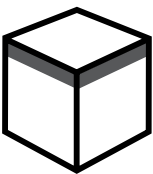
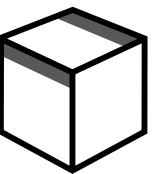
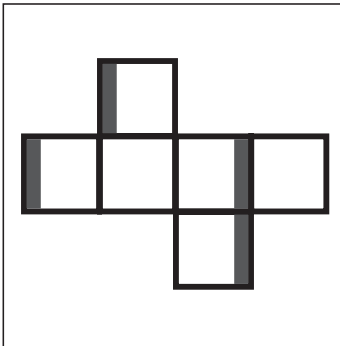

A

B

C

D

29.

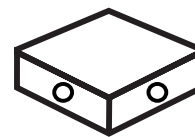
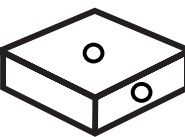
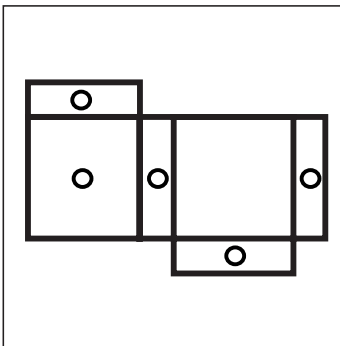

A

B

C

D

30.

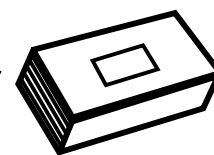
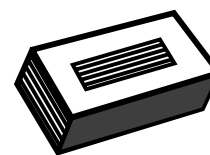
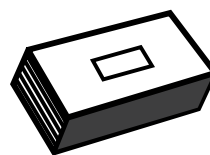
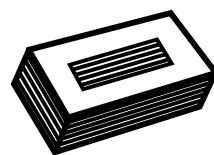
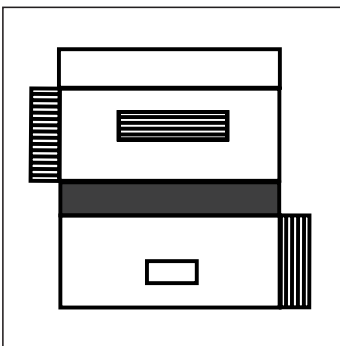

A

B

C

D

DO NOT START THE NEXT TEST UNTIL YOU ARE TOLD TO DO SO.

Tamanna: An Aptitude Test - PA

Instructions

Find the space for **PA-07** in your Answer Sheet. Answer all questions as directed.

This test consists of 60 items, which are designed to see how quickly and accurately you can compare letter and/or number combinations.

First, you will be shown a test item consisting of numbers, letters or letter- number combination. Then, it is followed by four options, viz. A, B, C and D which have the same test numbers/ letters/ letter-number combination, but in a different order. Only one of these options is exactly the **same** as the test item. Select the correct option which is same as the test item and mark on the answer sheet.

Example X

39461084

- A. 39416084
- B. 39461840
- C. 39461084
- D. 39461480

All the combinations given in the options appear similar. However the sequence of numbers is different except in 'C'.

In this example, right answer is "C", therefore, while marking answer C in the answer sheet, darken the circle of option C as shown below:

Correct way of marking the answer 

Practice Item:

L7LL77L2

- A. L7LLL772
- B. L7LL7L72
- C. L7L7LL72
- D. L7LL77L2

You are to mark the correct answer of the practice item in the answer sheet.

Answer: D

You will have **10 minutes** for this test. Work as quickly and accurately as possible.

DO NOT MARK ANYTHING ON THIS BOOKLET.

1. **48219357**
 - A. 48219357
 - B. 48129357
 - C. 48219537
 - D. 48291357
2. **PYDXZLQI**
 - A. PYDZXLQI
 - B. PYDXZQLI
 - C. PYDXZLQI
 - D. PYDXZIQI
3. **ZZZzZeEz**
 - A. ZzZzZeEz
 - B. ZZZZZeEz
 - C. ZzZzZeEz
 - D. ZZZzZeEz
4. **vWtfMnIL**
 - A. VWtfMnIL
 - B. vWtfMnIL
 - C. vWTfMnIL
 - D. vWtfMNIL
5. **7F7EFEE7**
 - A. 7F7EFEE7
 - B. 7f7EFEE7
 - C. 7F7fFEE7
 - D. 7F7EFeE7
6. **29483148**
 - A. 29483184
 - B. 29481348
 - C. 29438148
 - D. 29483148
7. **46249051**
 - A. 46240951
 - B. 46249051
 - C. 46429051
 - D. 42649051
8. **14114411**
 - A. 14414111
 - B. 14411411
 - C. 14114411
 - D. 14114441
9. **25798461**
 - A. 25798461
 - B. 25978461
 - C. 25798641
 - D. 25789461
10. **j9a99j9a**
 - A. j9a9j99a
 - B. j99a9j9a
 - C. j9a99j9a
 - D. ja999j9a
11. **2a22k2ak**
 - A. 2a22k2ak
 - B. 2a22ak2k
 - C. 2a22ka2k
 - D. 22ka22ak
12. **44372274**
 - A. 43472274
 - B. 44372274
 - C. 44372724
 - D. 44327724
13. **32983403**
 - A. 39283403
 - B. 39238403
 - C. 32938043
 - D. 32983403
14. **66292422**
 - A. 66292422
 - B. 64292622
 - C. 66429622
 - D. 66229242
15. **66348648**
 - A. 66384648
 - B. 63648468
 - C. 66348648
 - D. 63684648
16. **aMhoFOFU**
 - A. amhoFOFU
 - B. aMhoFOFU
 - C. aMhoFFOU
 - D. aMhOoFFU

17. **hBseUvWH**

- A. HBseUvWH
- B. hBSeUvWH
- C. hBseUvWH
- D. hBsEUvWH

18. **edYieSVc**

- A. edyieSVc
- B. eDYiEsVc
- C. EdYiSeVc
- D. edYieSVc

19. **51617141**

- A. 51617114
- B. 51617141
- C. 51611417
- D. 51614711

20. **UaMPPfKL**

- A. UaMPPfKL
- B. UAmPfpKL
- C. UampPfkKL
- D. UAMppfKL

21. **eWuVSpOF**

- A. ewuVSpOF
- B. eWuVSpOF
- C. eWuSVpoF
- D. ewUVSpof

22. **yXvghpBd**

- A. yXvghbPd
- B. vXyGhpBd
- C. yXvghpBd
- D. yxVGhpBd

23. **kHMs8092**

- A. KhMs8092
- B. kHMs8092
- C. Khms8092
- D. KhMs8092

24. **reCA0821**

- A. reCA0281
- B. reCA8021
- C. erCA0821
- D. reCA0821

25. **hGBz6216**

- A. hGBz6216
- B. hGBz6261
- C. hGBz6621
- D. hgBz6216

26. **jzVw3978**

- A. jzvw3978
- B. jZVw3978
- C. jzVw3978
- D. JzVw3978

27. **3037KxRd**

- A. 3073KxRd
- B. 3037KxRd
- C. 3037KXRd
- D. 3073KxRD

28. **nViP9797**

- A. NviP9797
- B. nViP7979
- C. nVIP9797
- D. nViP9797

29. **88RBbD17**

- A. 88RBBD17
- B. 88RbBD17
- C. 88RBbD17
- D. 88RBbd17

30. **97JkGs90**

- A. 97JkGs90
- B. 97JKGs90
- C. 97JkGS90
- D. 97Jkgs90

31. **51FfEe61**

- A. 51fFeE61
- B. 51FfeE61
- C. 51FfEe61
- D. 51eEfF61

32. **MN3643NN**

- A. Mn3643NN
- B. MN3643NN
- C. MN3643nN
- D. MN6343NN

33. vs6389nU

- A. vs6389NU
- B. vs6398nU
- C. vS6389nU
- D. vs6389nU

34. VO8073wN

- A. VO8073wN
- B. Vo8073wN
- C. VO8073WN
- D. VO8037wN

35. 435901dB

- A. 345901dB
- B. 435910dB
- C. 435901db
- D. 435901dB

36. j7004gsJ

- A. j7004gsJ
- B. j7004gSJ
- C. J7004gsJ
- D. j0704gsJ

37. 169429nm

- A. 169249nm
- B. 169429mn
- C. 169429nm
- D. 169249mn

38. 4825syBp

- A. 4825syBP
- B. 4825syBp
- C. 4852syBp
- D. 8425SyBp

39. AV3853Va

- A. Av3853Va
- B. AV3583Va
- C. AV3853Va
- D. AV3853va

40. UL8013TQ

- A. UL8103TQ
- B. UL8103tQ
- C. UL8013tQ
- D. UL8013TQ

41. BYfpaoSM

- A. ByFpaOsM
- B. ByfPAosM
- C. BYfpaoSM
- D. BYFpAosM

42. pdLrcVEc

- A. pDLrcvEC
- B. pdlRCvEC
- C. pdlRCVEc
- D. pdLrcVEc

43. 87249117

- A. 82794117
- B. 87942171
- C. 87249117
- D. 89724171

44. WuNRReHZ

- A. WUnRREhZ
- B. WuNRrehZ
- C. WUNrreHZ
- D. WuNRReHZ

45. AXoBDqEG

- A. AxObDQeG
- B. AXoBDqEG
- C. AXobdqEG
- D. AxOBdQeG

46. TCzhjyGp

- A. TcZHjYGP
- B. TCzhJYgP
- C. TCZhjygP
- D. TCzhjyGp

47. LJNx9269

- A. LjNX9296
- B. LJNx9269
- C. LJnx2969
- D. LjnX9629

48. scVB3874

- A. scVB3874
- B. scVb3784
- C. sCvB3847
- D. scVb8374

49. **yFDw7117**

- A. yFdW1717
- B. yfDw1177
- C. yFDw7117
- D. yfdW1771

50. **kaCQ5883**

- A. kaCQ5883
- B. kAcQ5838
- C. kaCq8583
- D. kAcQ8853

51. **4334HzPA**

- A. 4343HZpA
- B. 4334hZPA
- C. 4343hzpA
- D. 4334HzPA

52. **mZuA7919**

- A. mZUa7199
- B. mZuA7919
- C. mzUA7991
- D. mzua7919

53. **66Tnfs52**

- A. 6T6Nfs52
- B. 66TnFS25
- C. 66tNFs52
- D. 66Tnfs52

54. **85GJCx08**

- A. 85GjCX08
- B. 85GJCx08
- C. 85gjCx08
- D. 85GJcx80

55. **47IrFa90**

- A. 47iRFA90
- B. 47IRfa09
- C. 47IrFa90
- D. 4I7rFA09

56. **XW3883HH**

- A. XW3883HH
- B. Xw3838HH
- C. Xw3883hH
- D. XW3838hh

57. **zS5296mI**

- A. Zs5269mI
- B. zS5296mI
- C. zS5269MI
- D. ZS2596MI

58. **QW6144bX**

- A. QW6414Bx
- B. Qw6441bX
- C. Qw6144BX
- D. QW6144bX

59. **835372EF**

- A. 835372EF
- B. 853372eF
- C. 833527EF
- D. 835327eF

60. **qp9057LJ**

- A. qP9075LJ
- B. qp0975IJ
- C. qp9057LJ
- D. qP0957IJ

DO NOT START THE NEXT TEST UNTIL YOU ARE TOLD TO DO SO.